



Architecture Student Contest Saint-Gobain 2026 Bělehrad, Srbsko

129AAKA Kalivoda, Stark, Novik ČUVIT FSV A+S LS 25/26

Filip Bischof, Miroslav Tijzyna

Architecture Student Contest Saint-Gobain 2026 Bělehrad, Srbsko

129AAKA Kalivoda, Stark, Novik ČUVIT FSV A+S LS 25/26

Filip Bischof, Miroslav Tijzyna

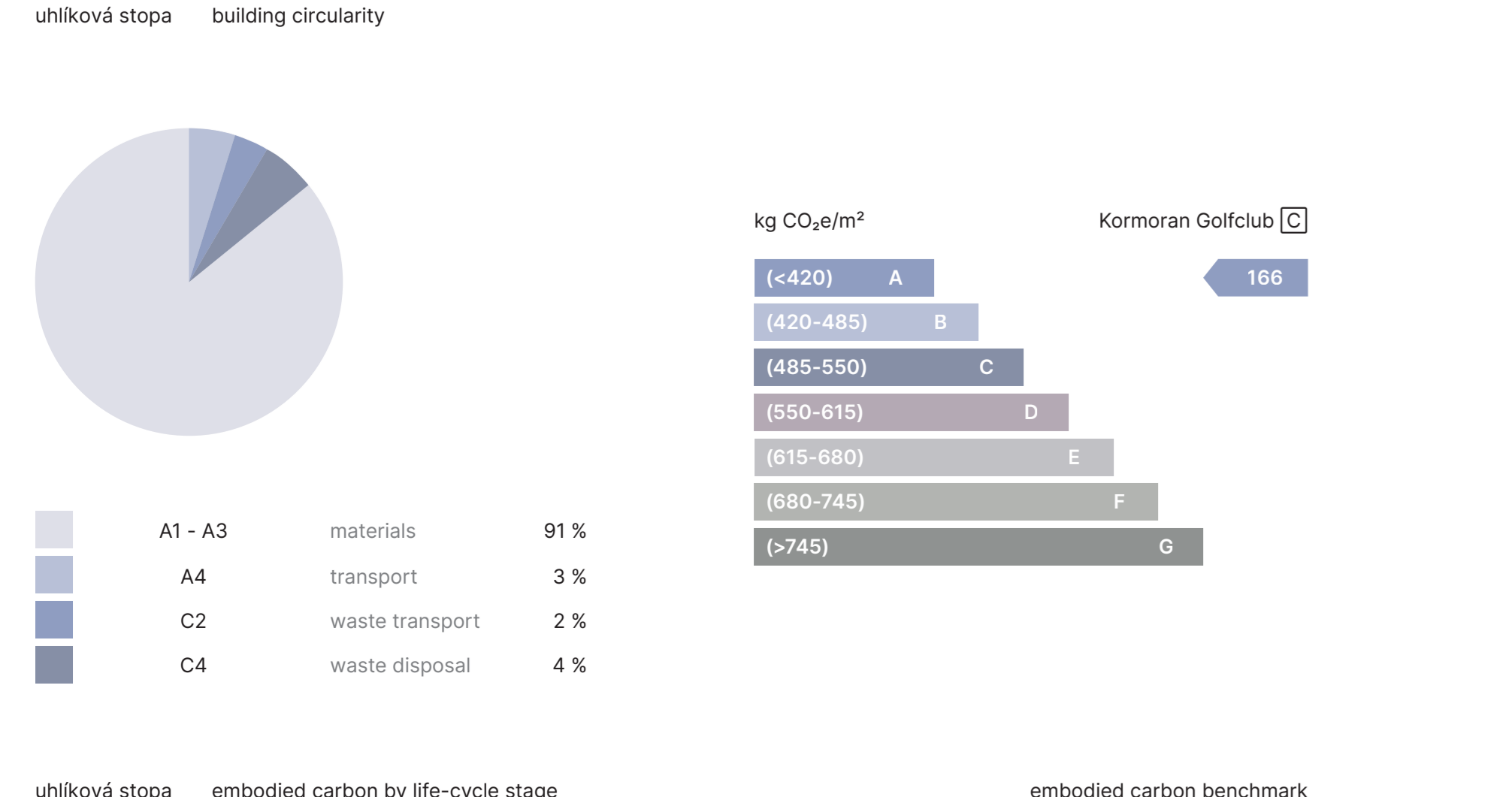
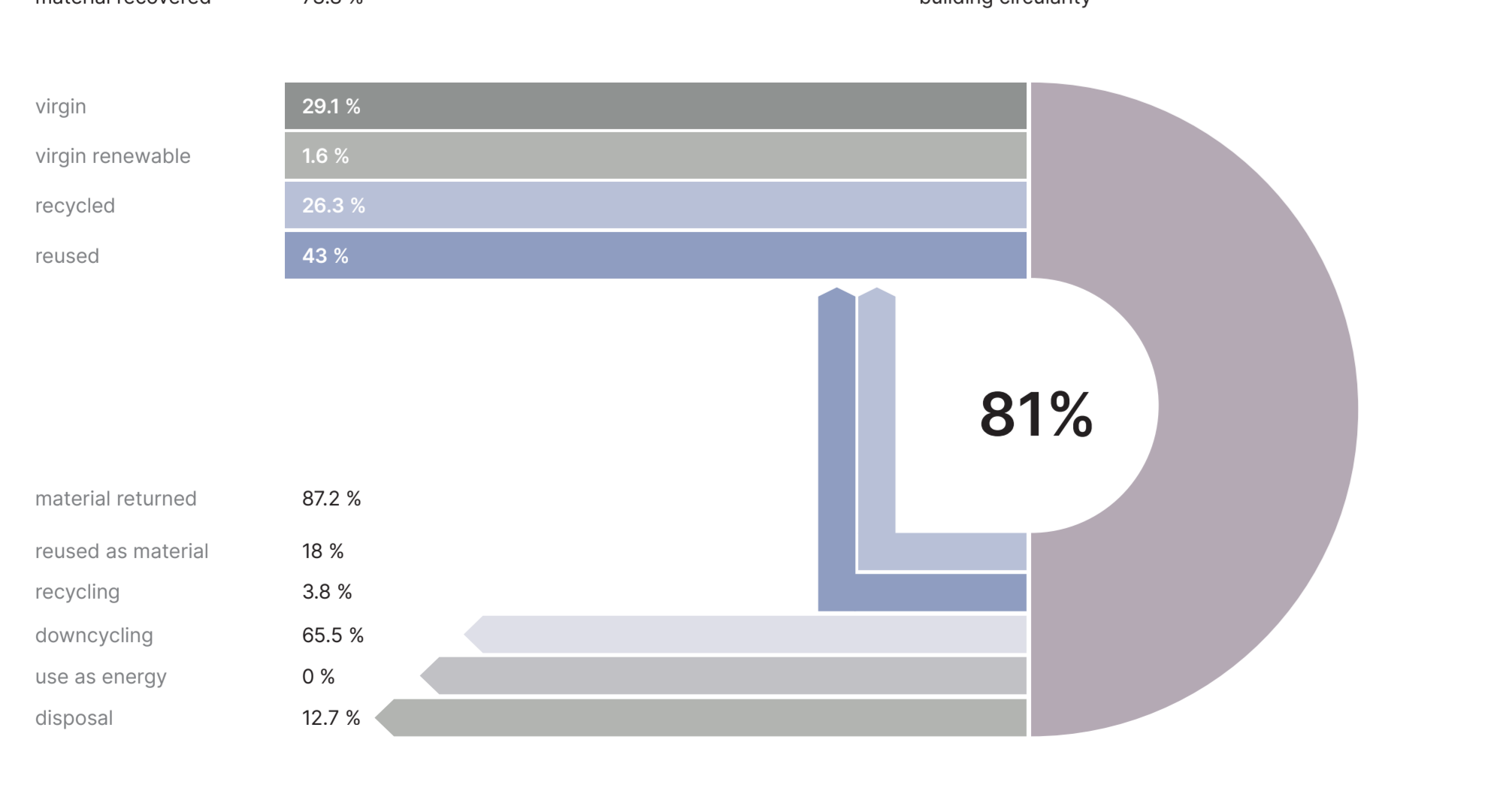
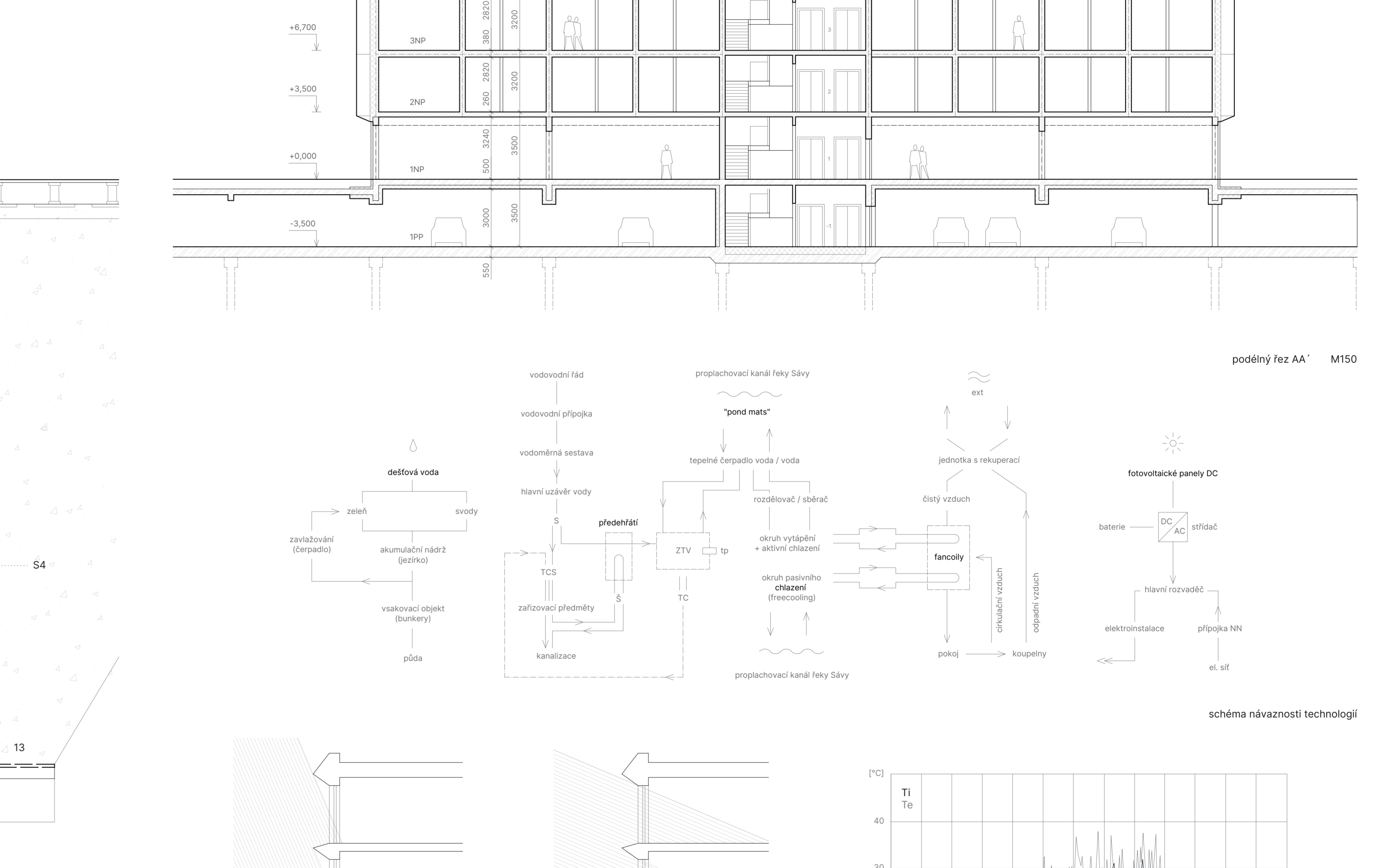
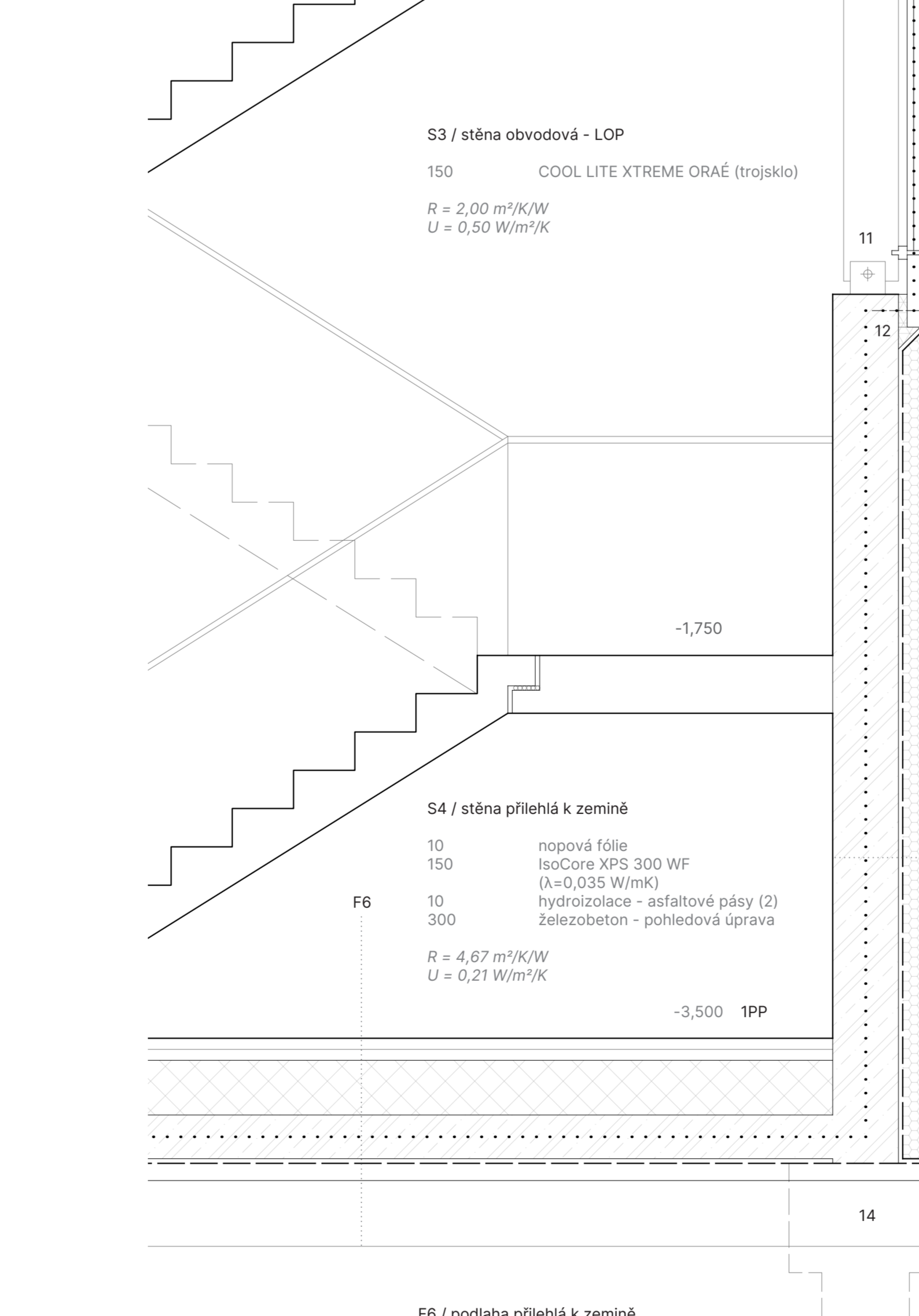
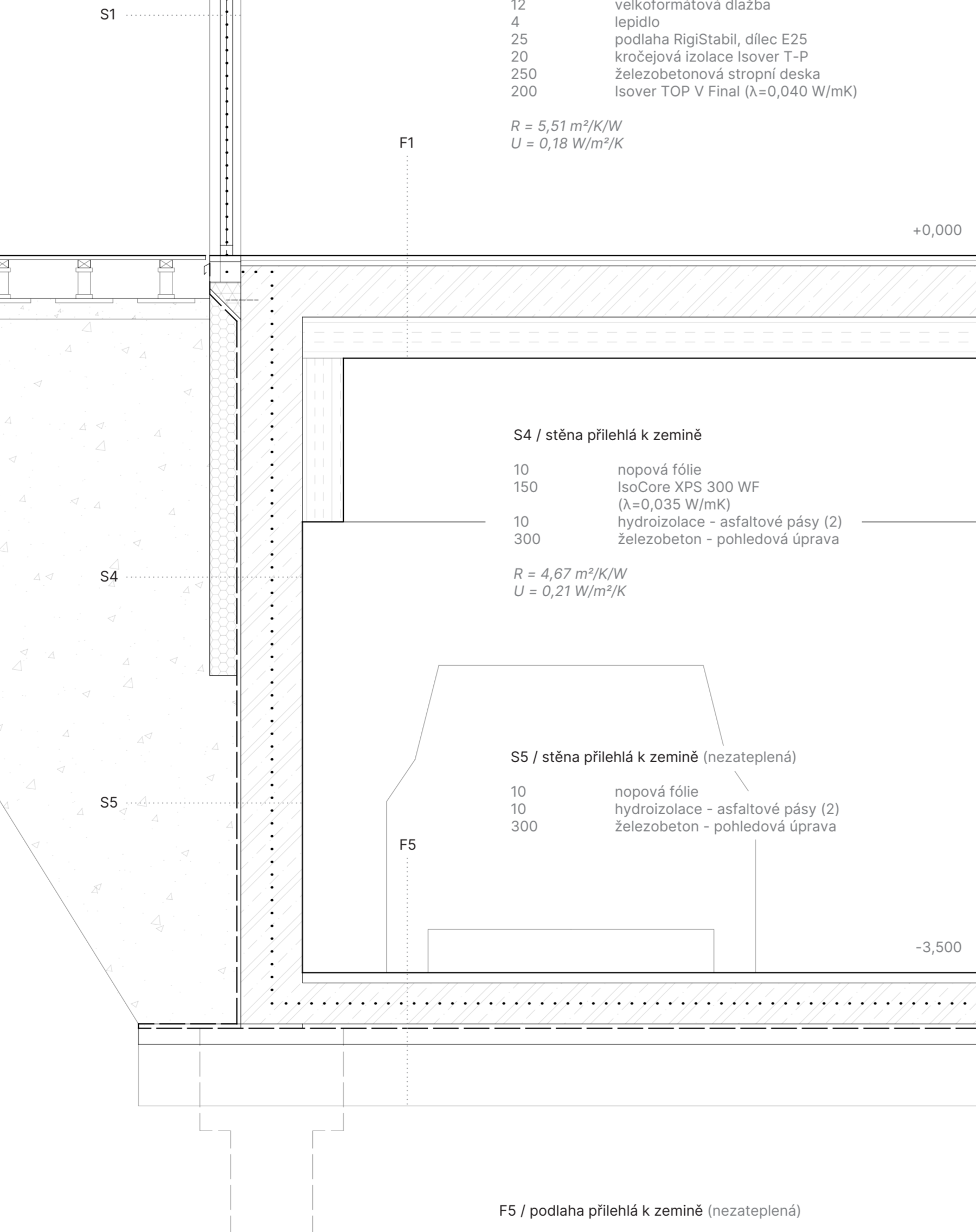
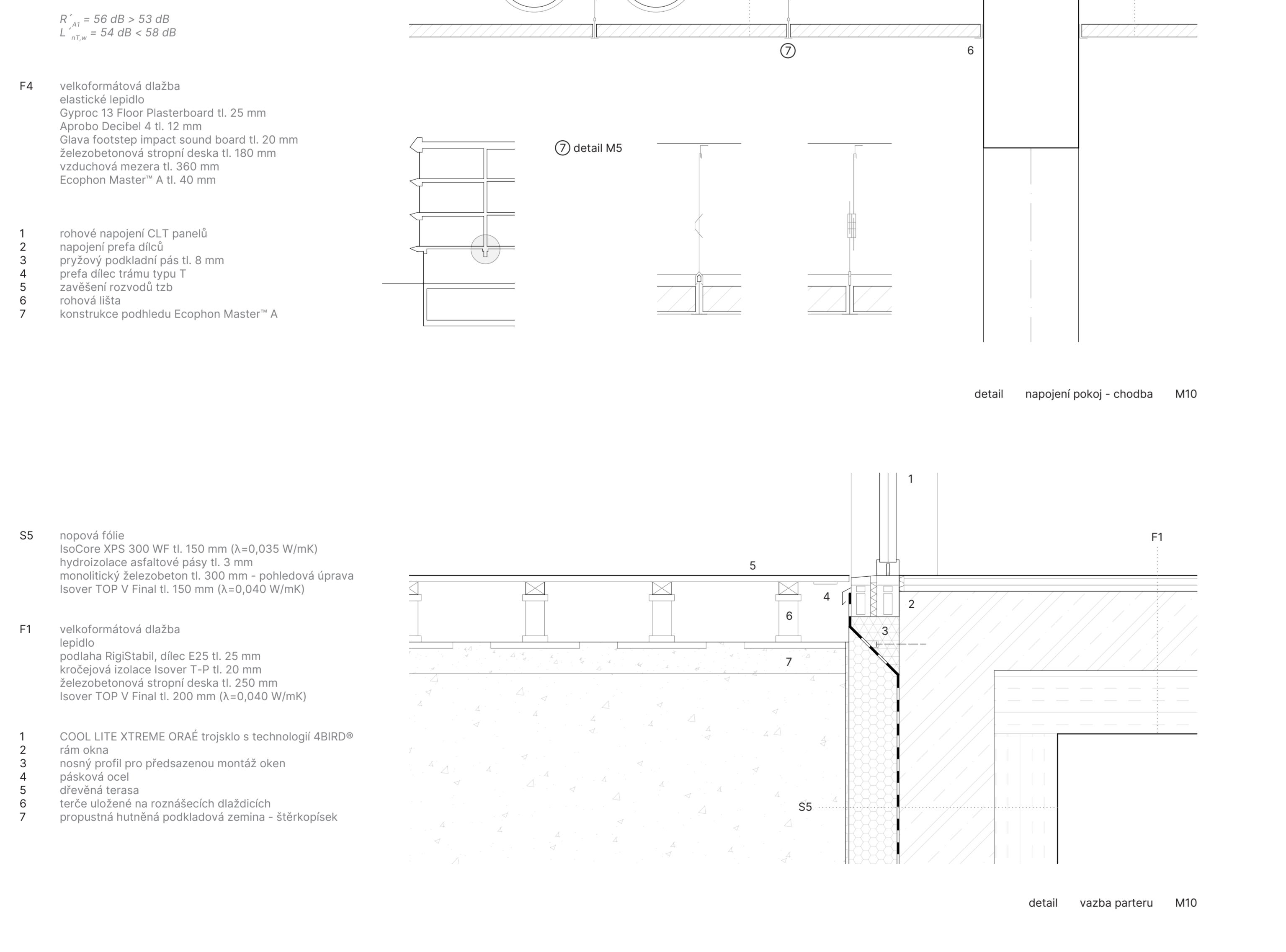
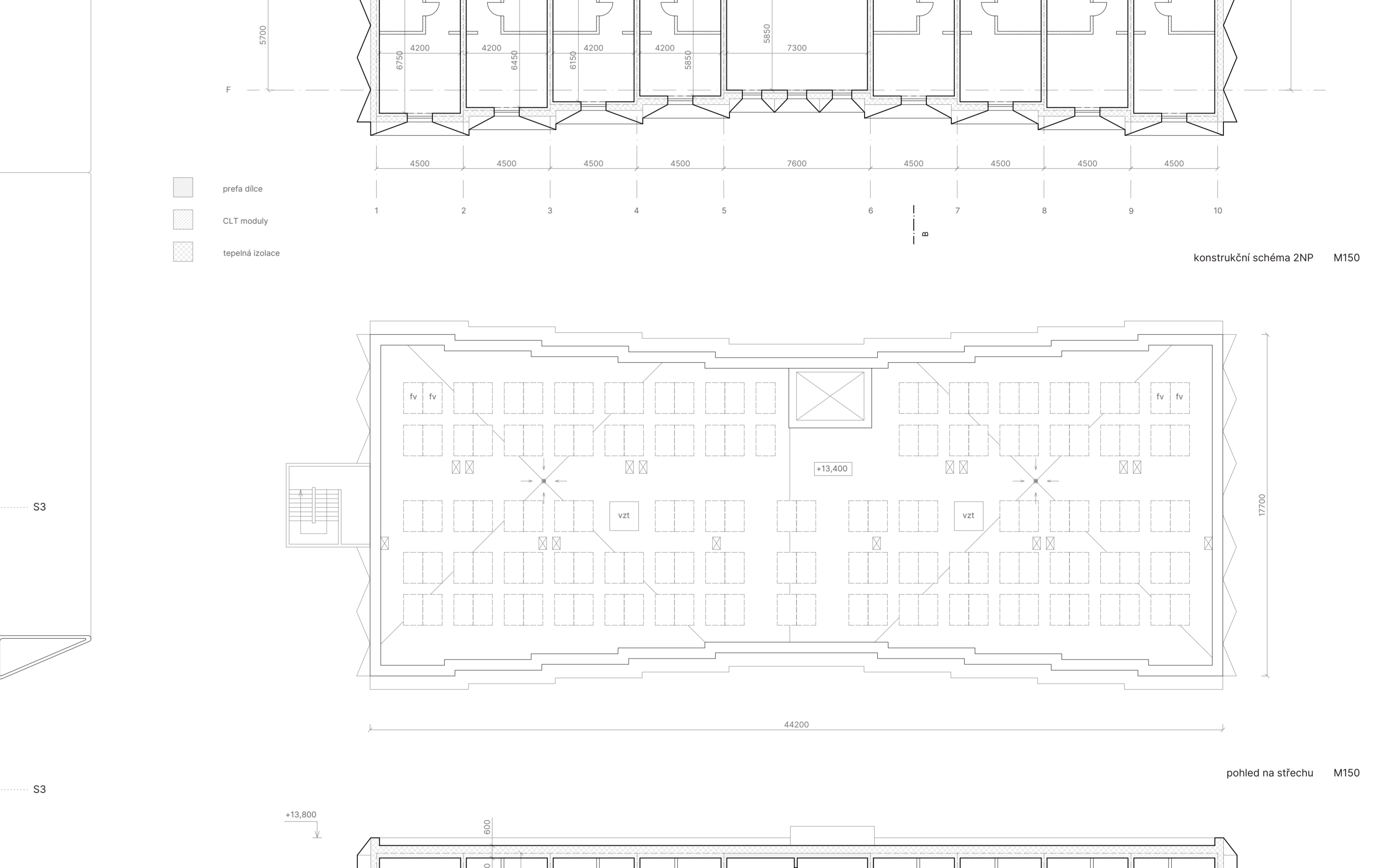
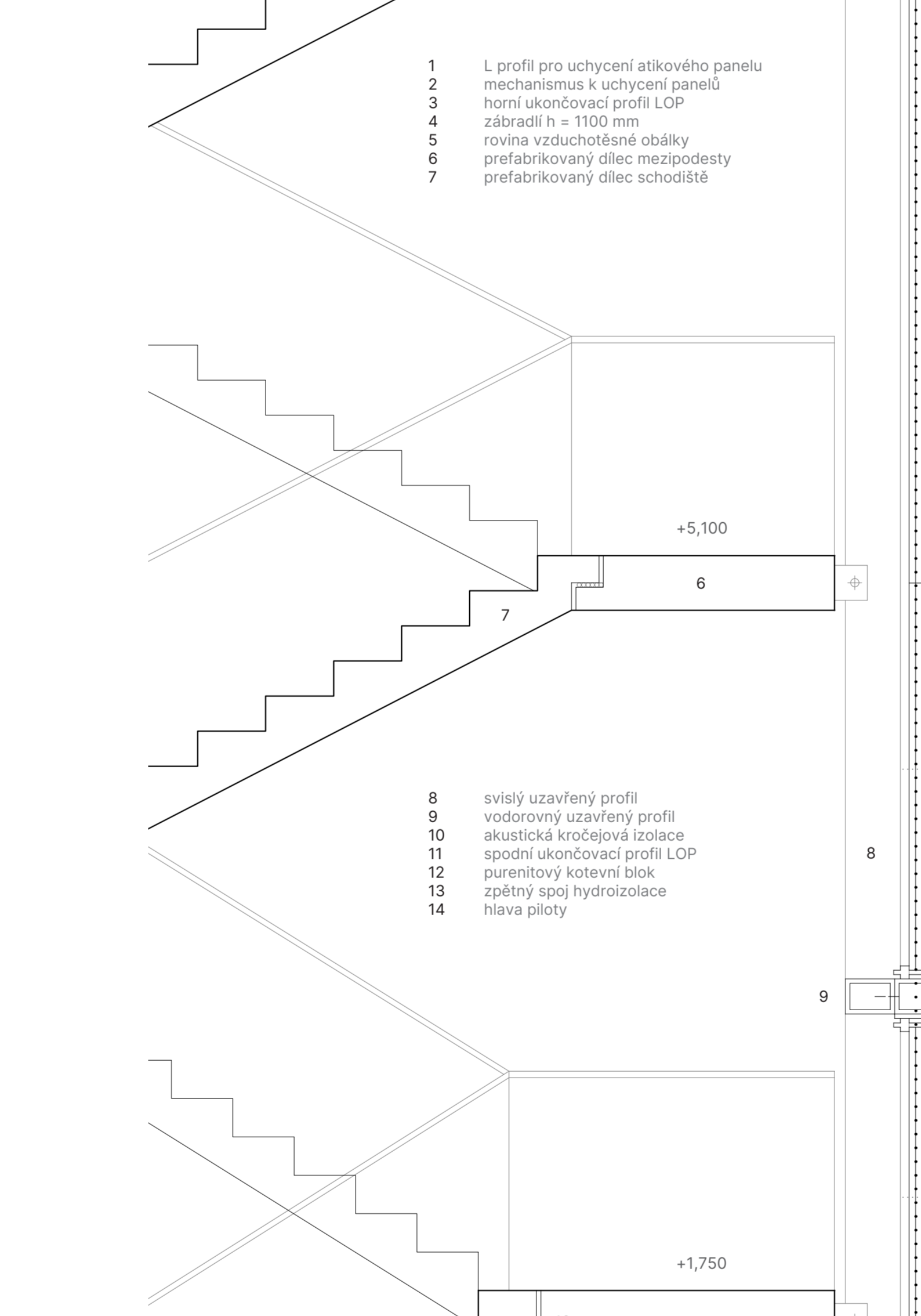
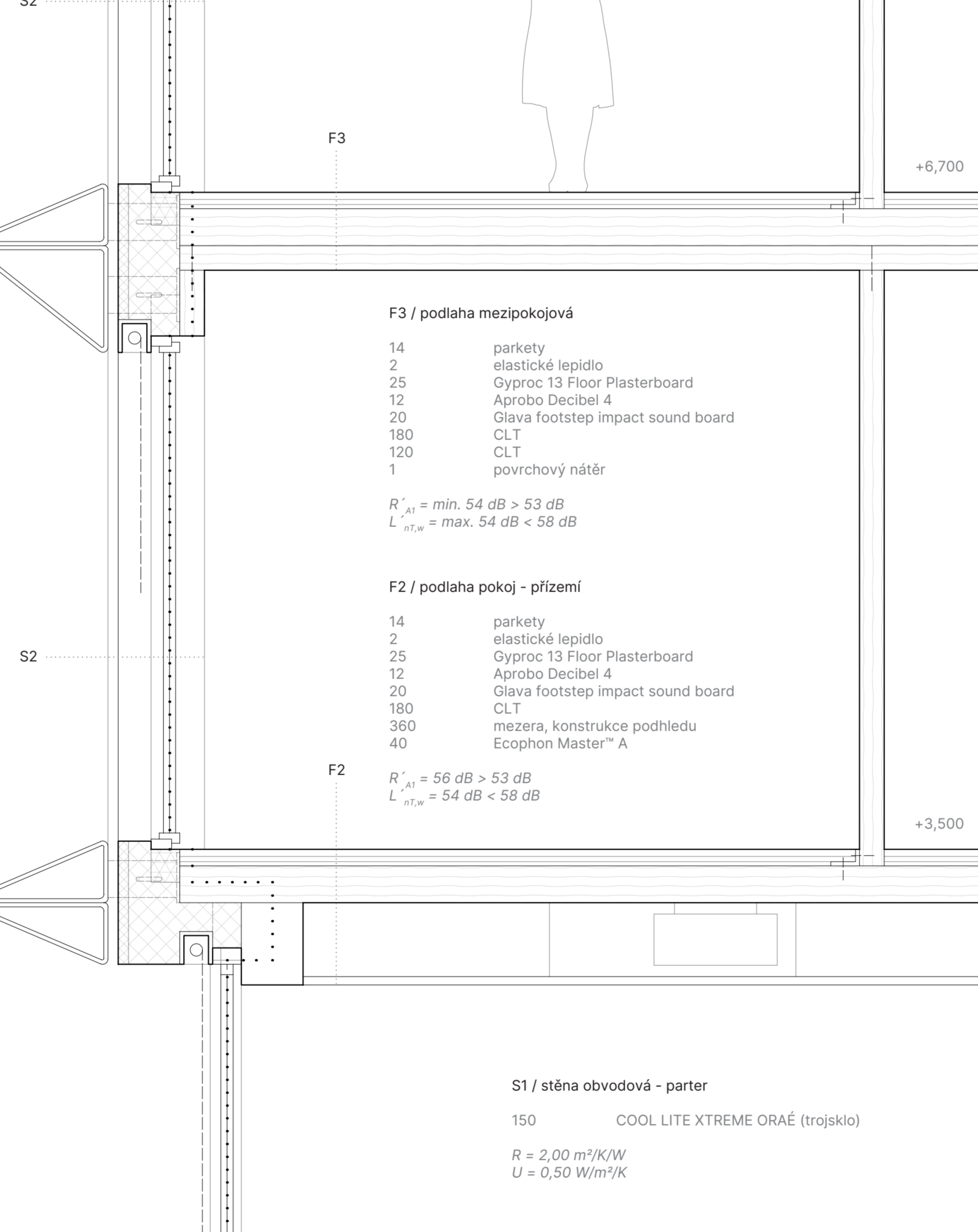
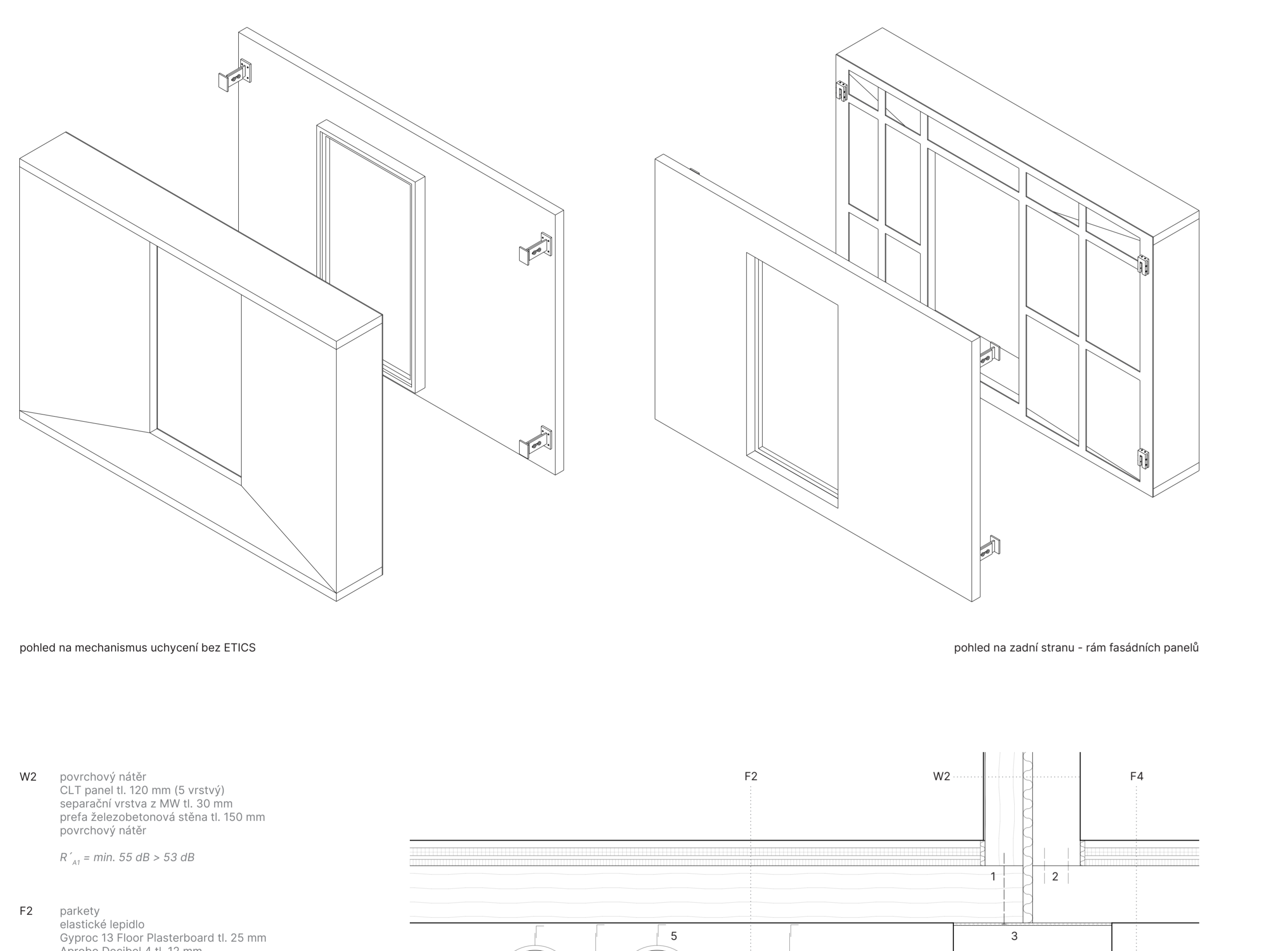
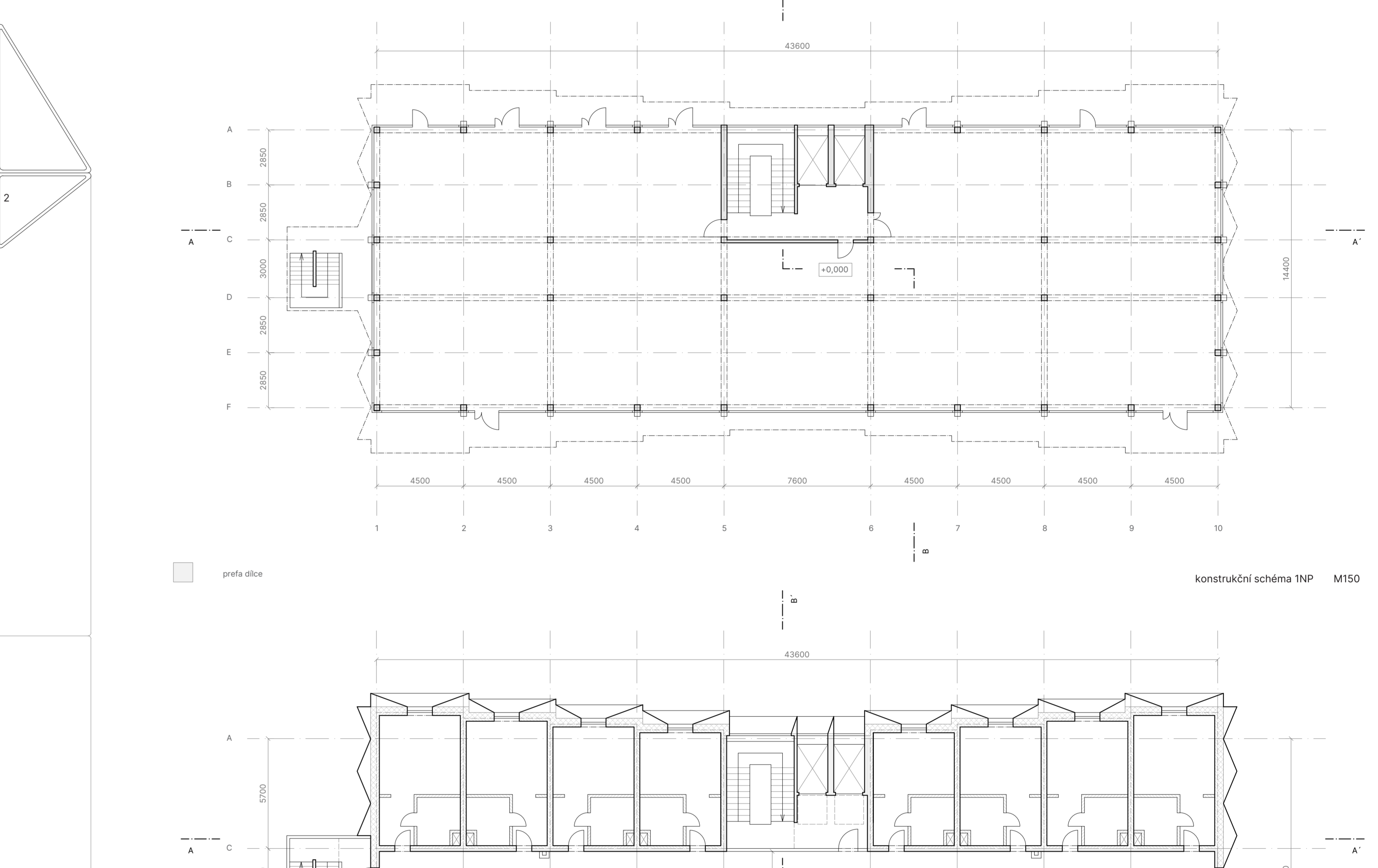
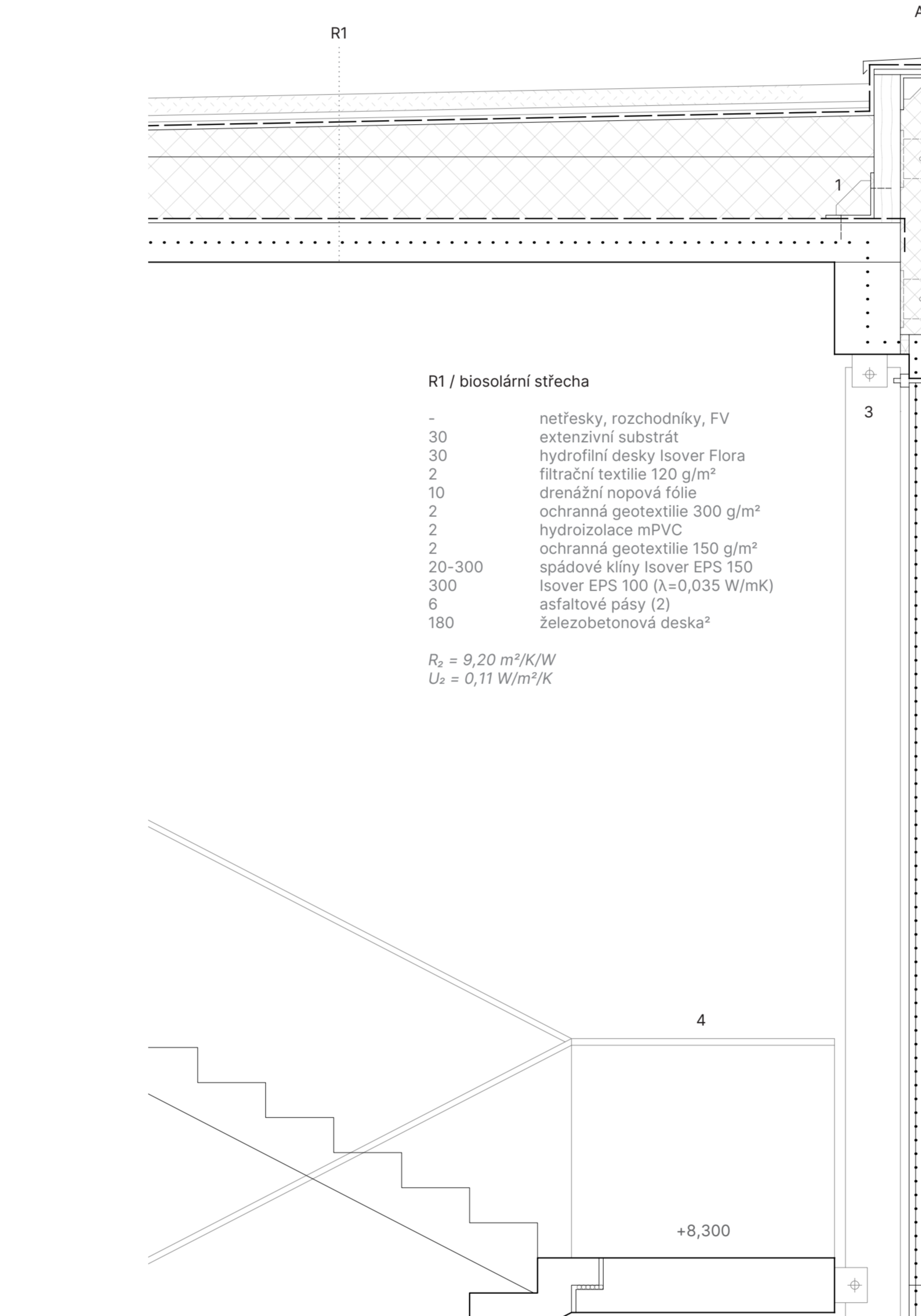
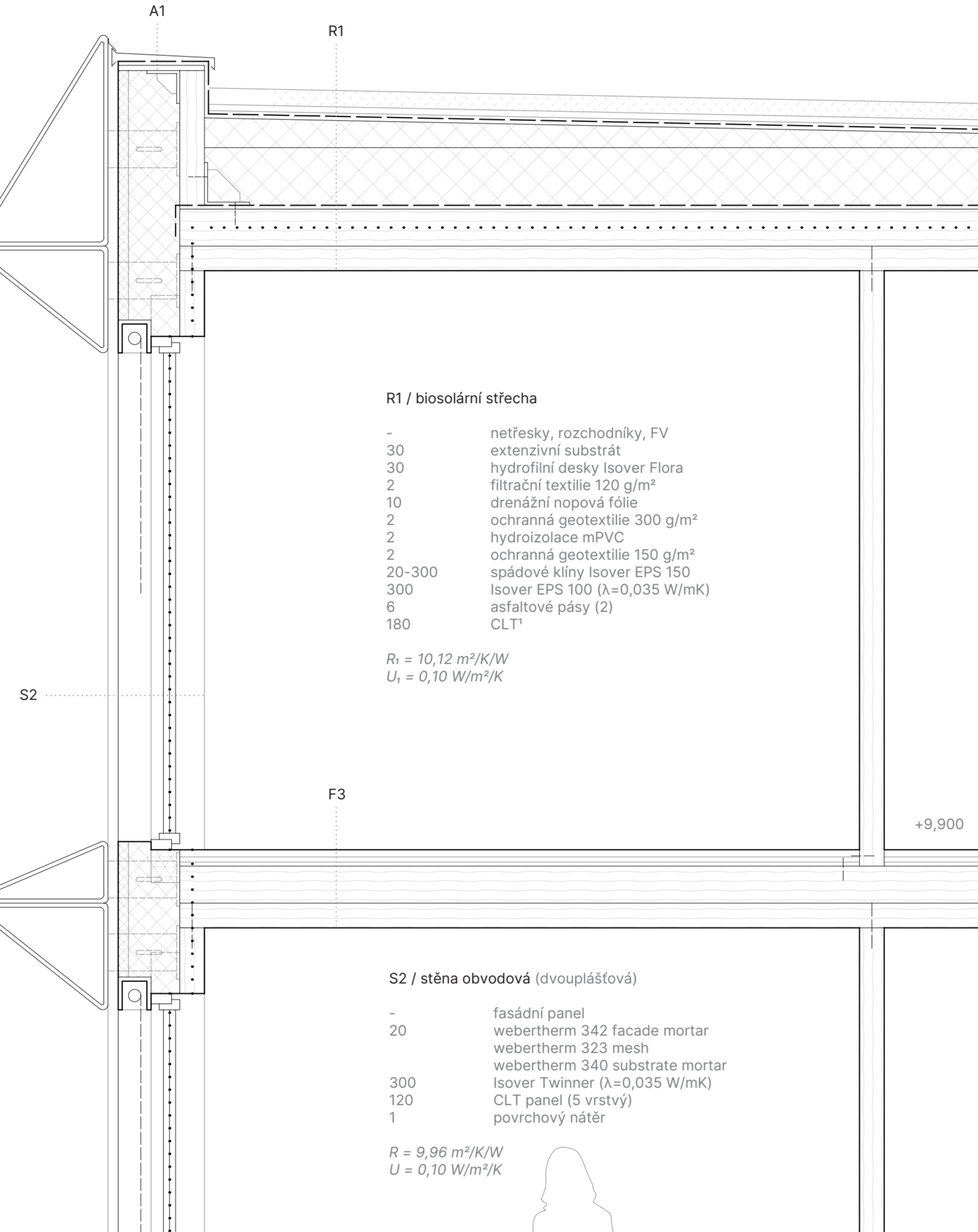
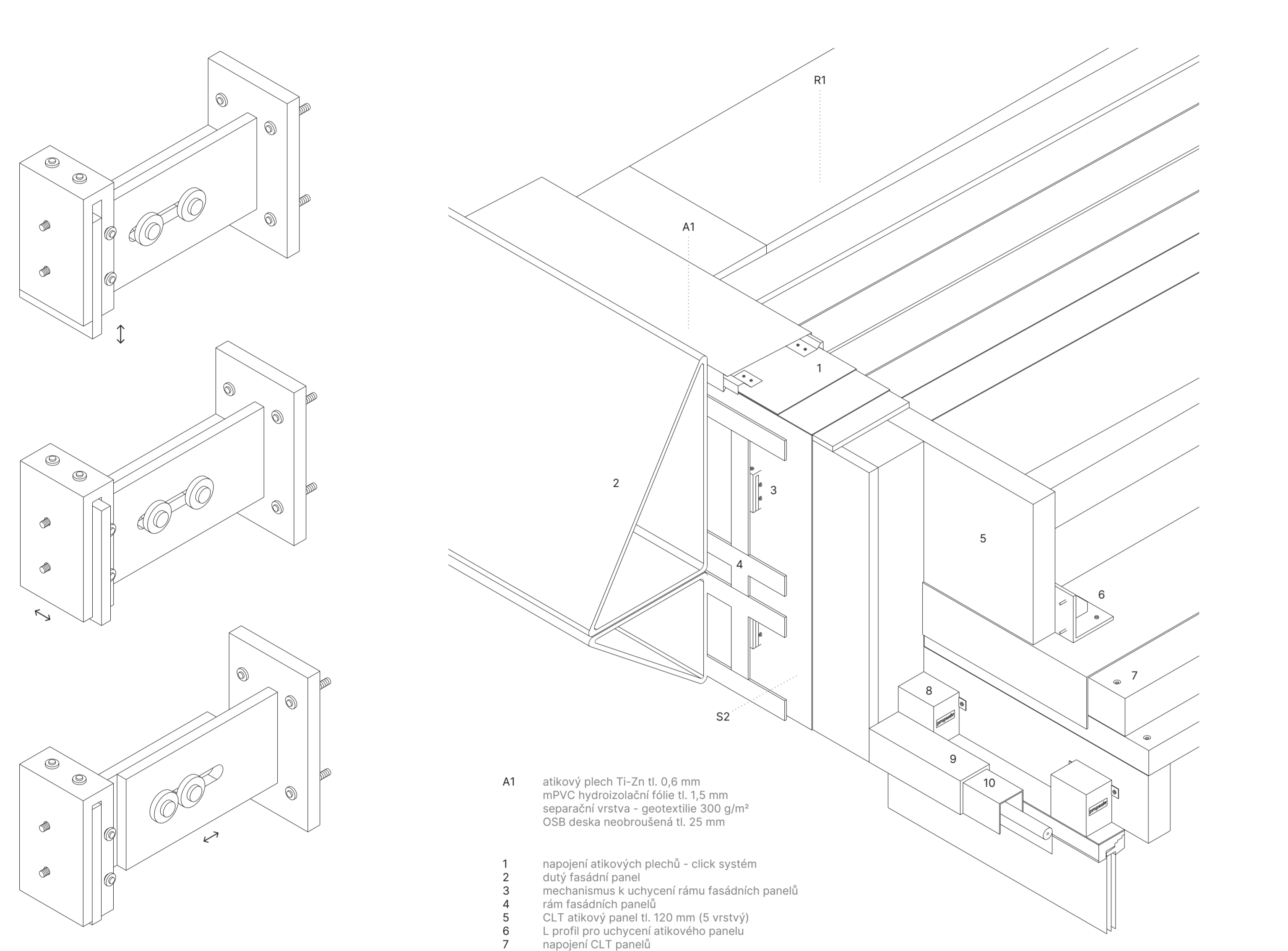
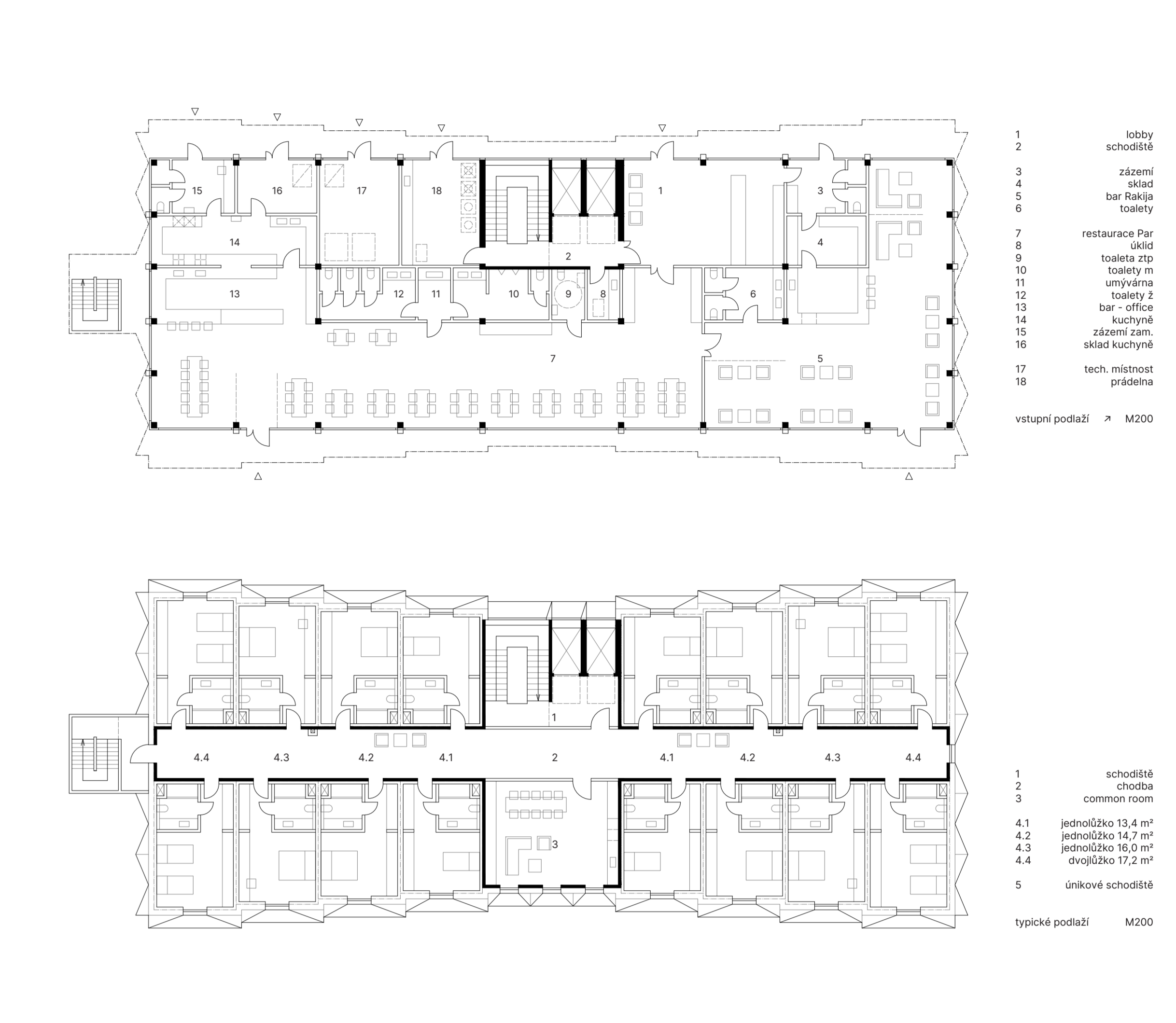
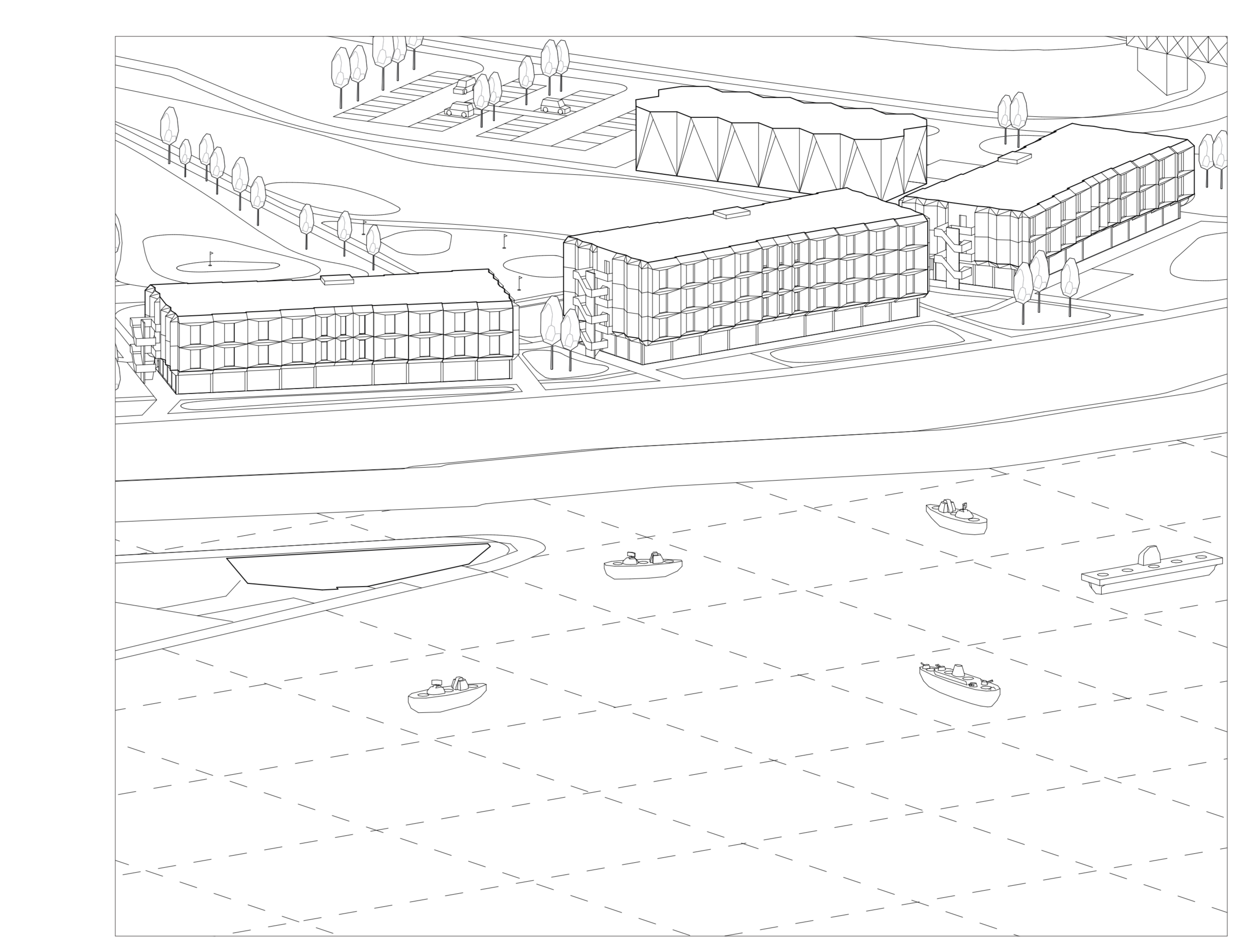
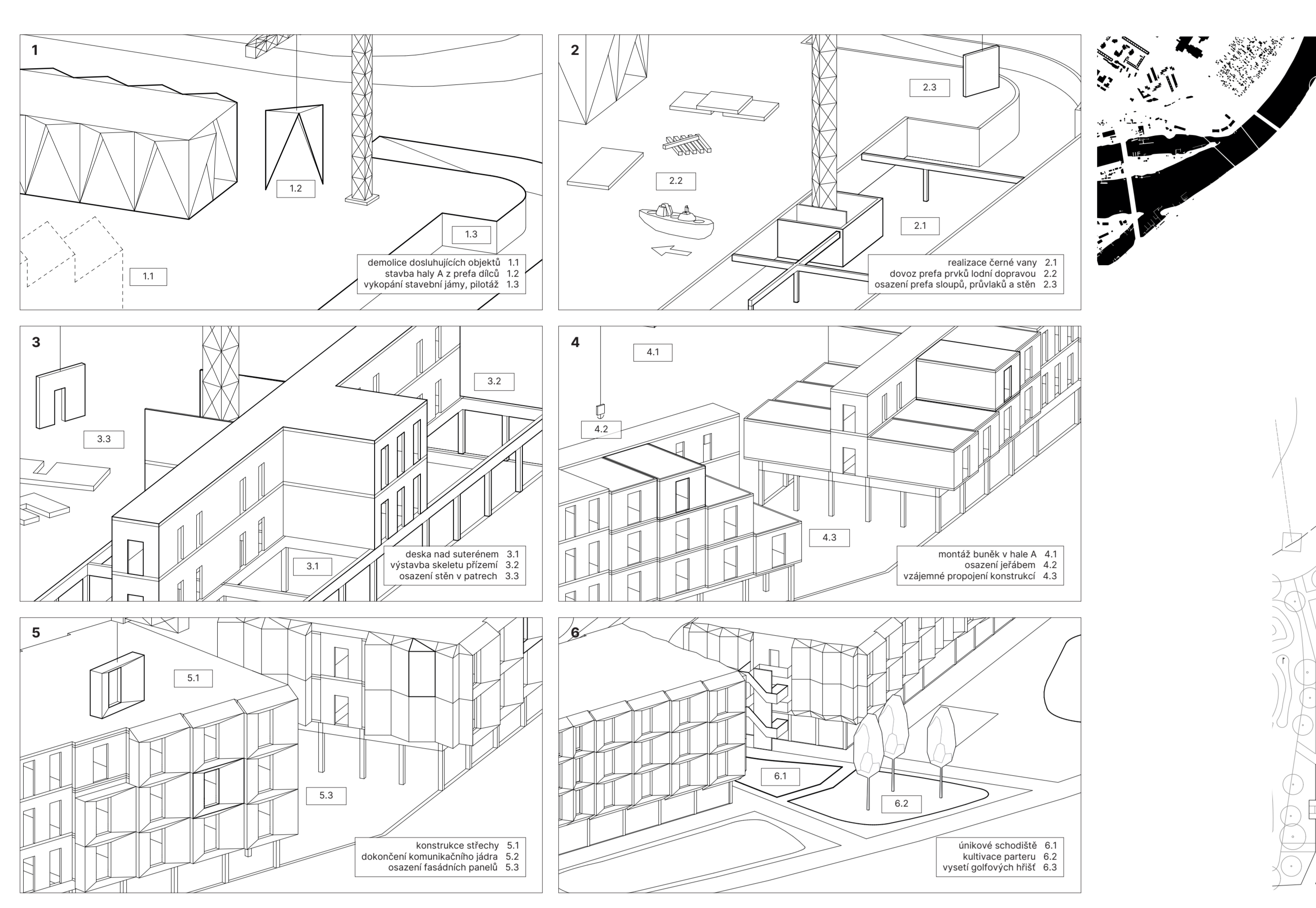

AJK 1934

QR code

zastřešená plocha 277 m²

podlažní plocha 400 m²

rekonstrukce

architektní úprava a podoba

využití

hanga pro A.K. Železná A.K. Mlýnská

technologie

tepelné čerpadlo voda - voda

tepelné čerpadlo

tepelné čerpadlo

tepelné čerpadlo

