



# MATRIX LOOP

THE COTTAGE IS FORMED BY INTERLOCKING FOLDED PLANES THAT WRAP AROUND A CENTRAL DOUBLE-HEIGHT SPACE SIMILAR TO THE VISUAL LOGIC OF THE IMAGE. EACH "BRAND" BECOMES A ROOF ELEMENT, CREATING A DYNAMIC YET BALANCED FORM. INSPIRED FROM MÖBIUS STRIP.

Where Surface Flows Endlessly

## BUBBLE DIAGRAM

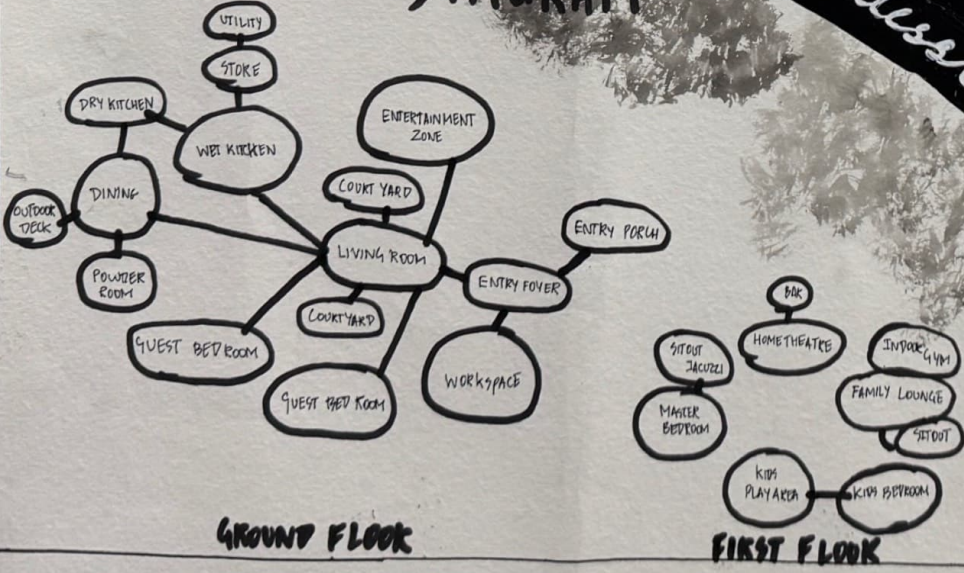

- ORIENTATION**
- DESIGNED TO MAXIMISE VIEWS, CROSS-VENTILATION AND SHADDED OUTDOOR SPACES
- SPATIAL EXPERIENCES**
- FLOATING, LIGHT & CONNECTED
- FORM & MASSING**
- INTERLOCKING HORIZONTAL SLABS
  - FLOCKS & ROOFS
  - ANGLED VERTICAL PLANES
  - WALLS, STRUCTURAL FINS
- CLIMATE**
- CROSS-VENTILATION VIA OPPOSITE OPENINGS
  - COURTYARD EFFECT IMPROVES AIRFLOW



Concept Sheet

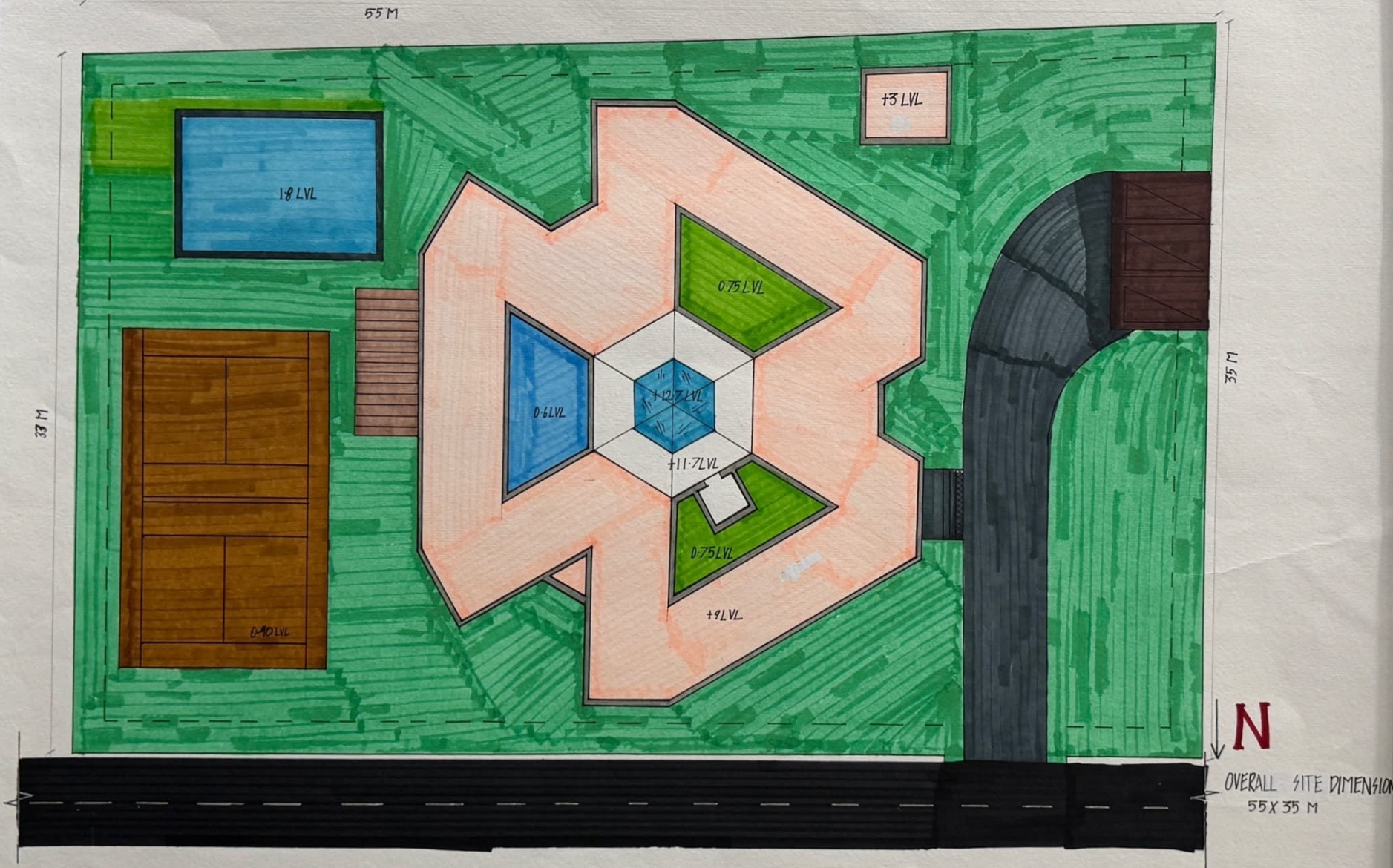

# WEEKEND COTTAGE SITEPLAN

NAME: MEERA  
 RRN: 251431601016  
 B-DES SEM-II  
 DESIGN ENVIRONMENT - II  
 CRESCENT SCHOOL OF ARCHITECTURE



S.NO	DOOR SCHEDULE	SIZE
1	MAIN DOOR [MD]	2.1 x 1.3M
2	DOOR 1 [D1]	2.1 x 0.9M
3	DOOR 2 [D2]	2.1 x 0.75M
4	SLEEPING DOOR [SD]	2.1 x

S.NO	WINDOW SCHEDULE	SIZE
1	VENTILATOR [VT]	1.0 x 0.6M
2	WINDOW 1 [W1]	1.5 x 1.5M
3	WINDOW 2 [W2]	1 x 1M



0.45  
0.75  
0.6

4.4

# WEEKEND COTTAGE GROUND FLOOR PLAN

NAME : MEDIA  
 RRN : 251431601016  
 B-DES SEM-11  
 DESIGN ENVIRONMENT  
 (PRESENT SCHOOL OF ARCHITECTURE)

55M

35M

35M

N



# WEEKEND COTTAGE FIRST FLOOR

NAME: MEDHA
RRN: 251431601016
DESIGN ENVIRONMENT - II
B-DES SEM-11
CRESCENT SCHOOL OF ARCHITECTURE

# SECTION AA'

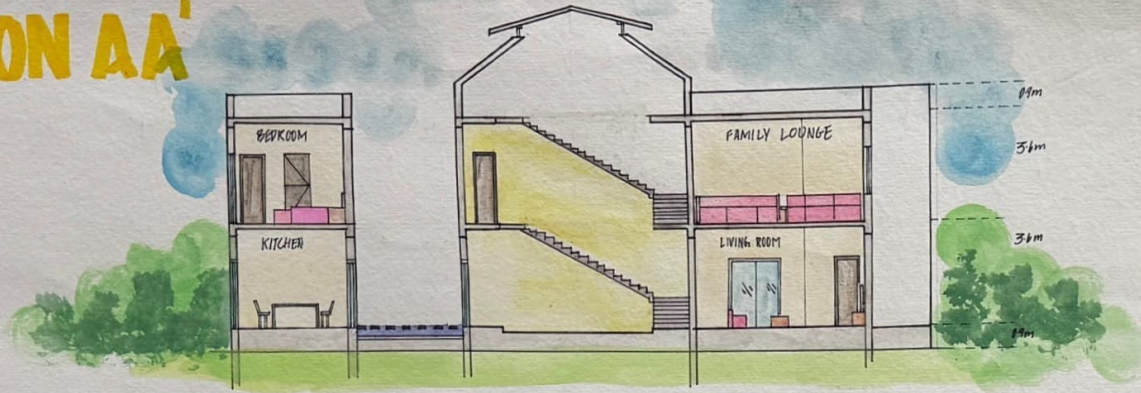

# SECTION BB'



# SECTION DD'

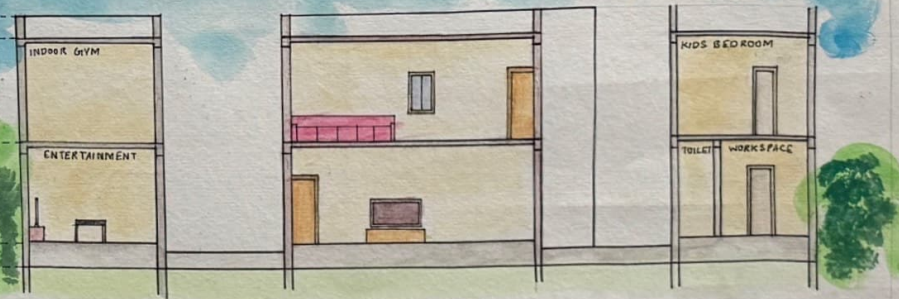

# SECTION CC'

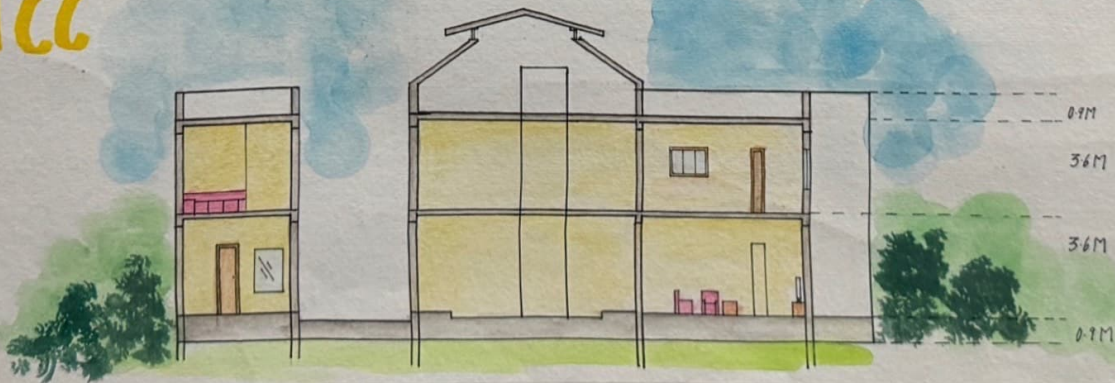

# WEEKEND COTTAGE SECTIONS

NAME: MEDHA  
 RRN: 251431601016  
 B-DES II-SEM  
 DESIGN ENVIRONMENT -11  
 CRESCENT SCHOOL OF ARCHITECTURE

## SIDE ELEVATION (NORTH)

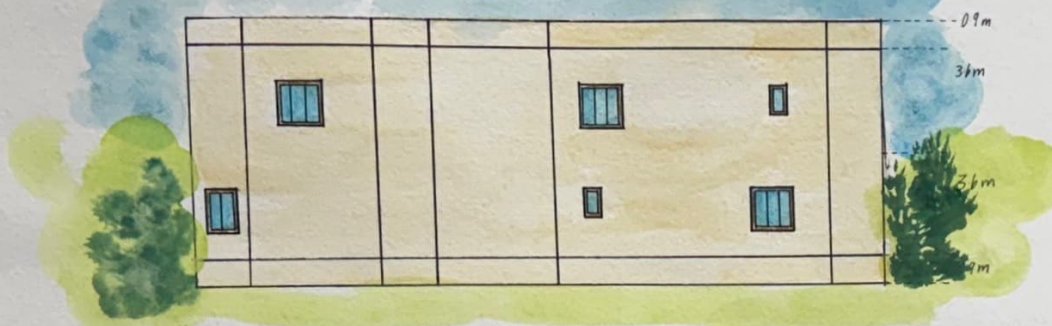

## SIDE ELEVATION (SOUTH)

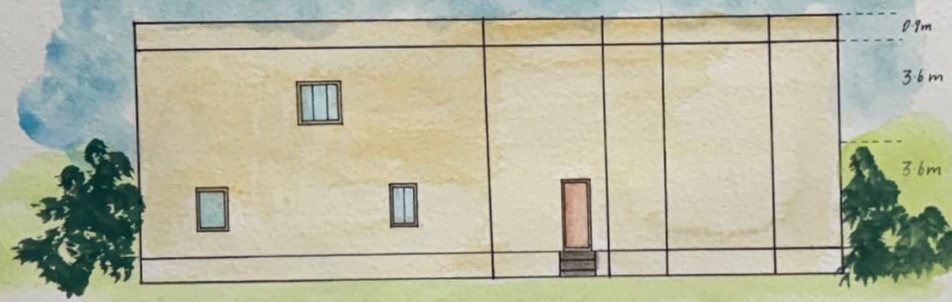

## FRONT ELEVATION



## REAR ELEVATION

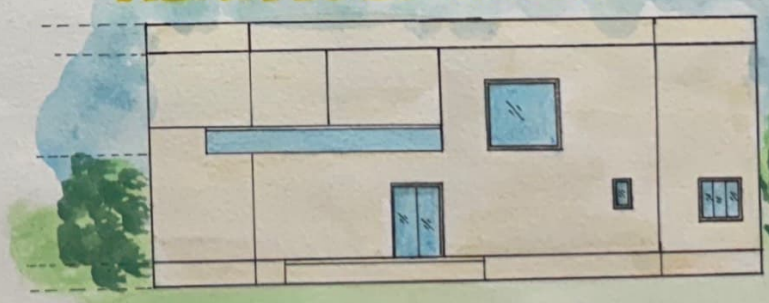

# WEEKEND COTTAGE ELEVATIONS

NAME: MEDHA  
RRN: 251931601016  
BDES SEM-11  
DESIGN ENVIRONMENT  
PRESTON SCHOOL OF ARCHITECTURE

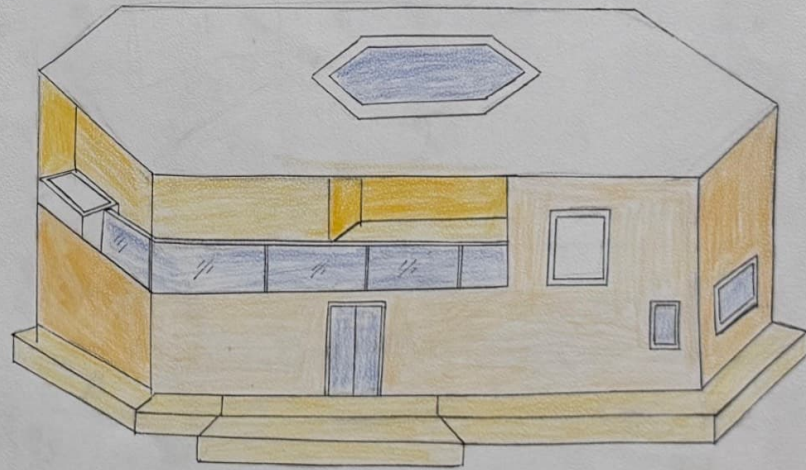
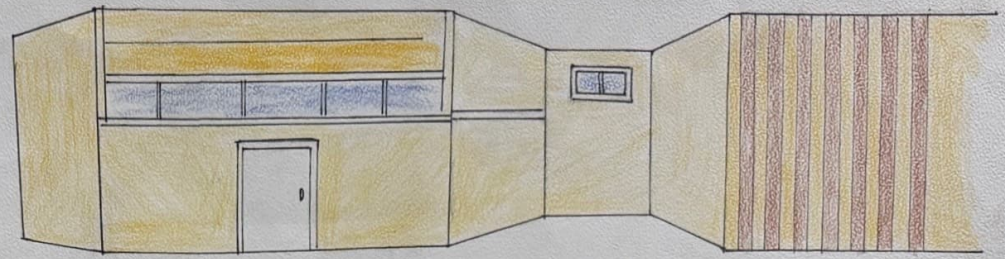
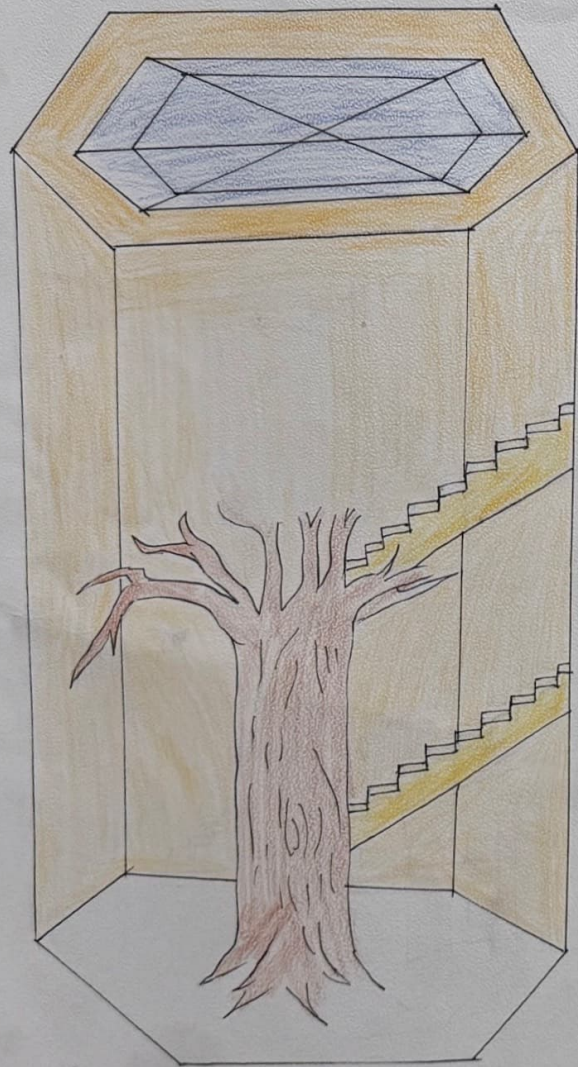

# WEEKEND COTTAGE VIEWS

NAME: MEDHA  
RRN: 251931621016  
DESIGN ENVIRONMENT-II  
BDES SEM-II



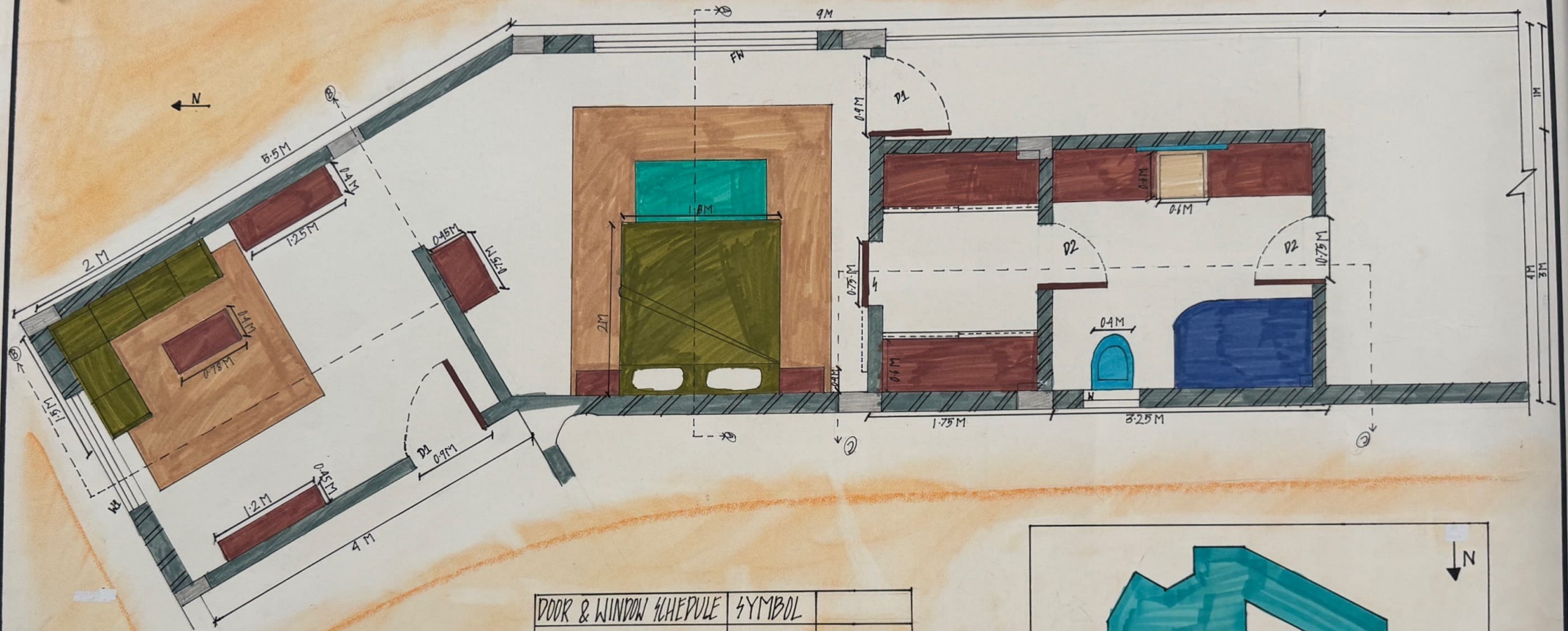

AREA DIMENSIONS	
AREA	DIMENSIONS
LOUNGE AREA	4 X 3.37 M
BEDROOM	4 X 4 M
WALK-IN-WARDROBE	3 X 1.75 M
TOILET	3 X 3.25 M

DOOR & WINDOW SCHEDULE	SYMBOL	
DOOR 1	D1	2.1 X 0.9 M
DOOR 2	D2	2.1 X 0.75 M
SLIDING DOOR	SD	2.1 X 0.75 M
EXHAUST WINDOW	V	1.8 X 0.6 M
VENTILATION WINDOW	W1	1.5 X 1.5 M
FIXED WINDOW	FW	2.1 X 2.5 M

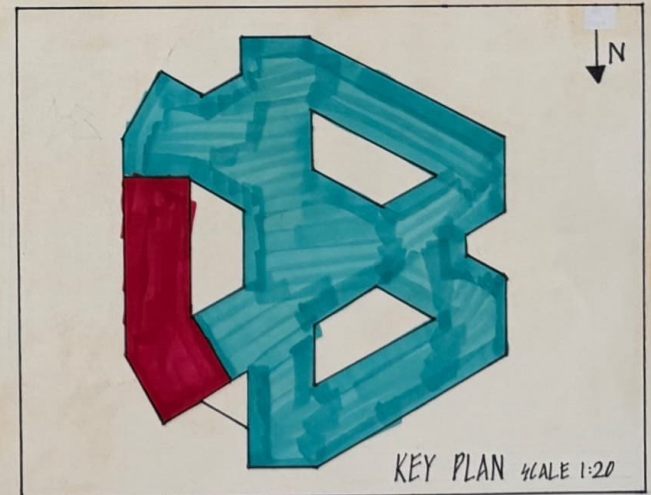

# SPACE PLANNING

NAME: MEVHA  
 RRN: 251431601016  
 DESIGN ENVIRONMENT - 11

# SKIRTING

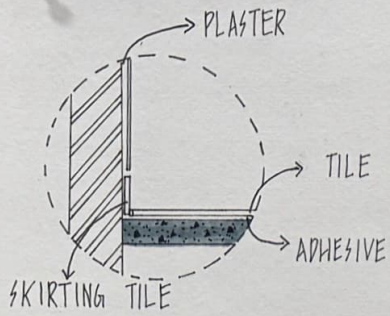

# GRROUTING

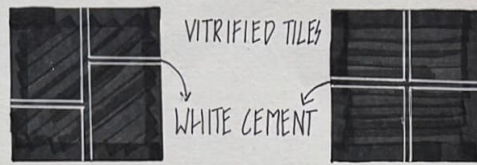

# FLOORING LAYOUT

# THRESHOLD

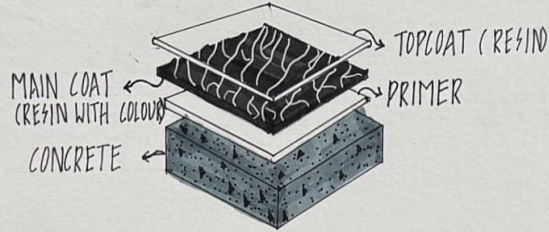
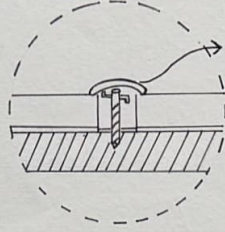

# JOINERY

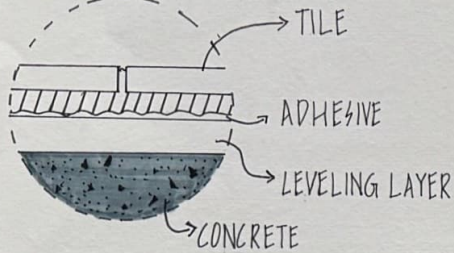

# SPECIFICATIONS :



MATERIAL : VITRIFIED TILES  
MATTE FINISH  
SIZE: 1' X 1' (0.3 X 0.3 M)  
2' X 2' (0.6 X 0.6 M)  
3' X 2' (0.9 X 0.6 M)



MATERIAL : EPOXY RESIN  
METALLIC FINISH



MATERIAL : VITRIFIED TILES  
MATTE FINISH  
SIZE : 2' X 2' (0.6 X 0.6 M)

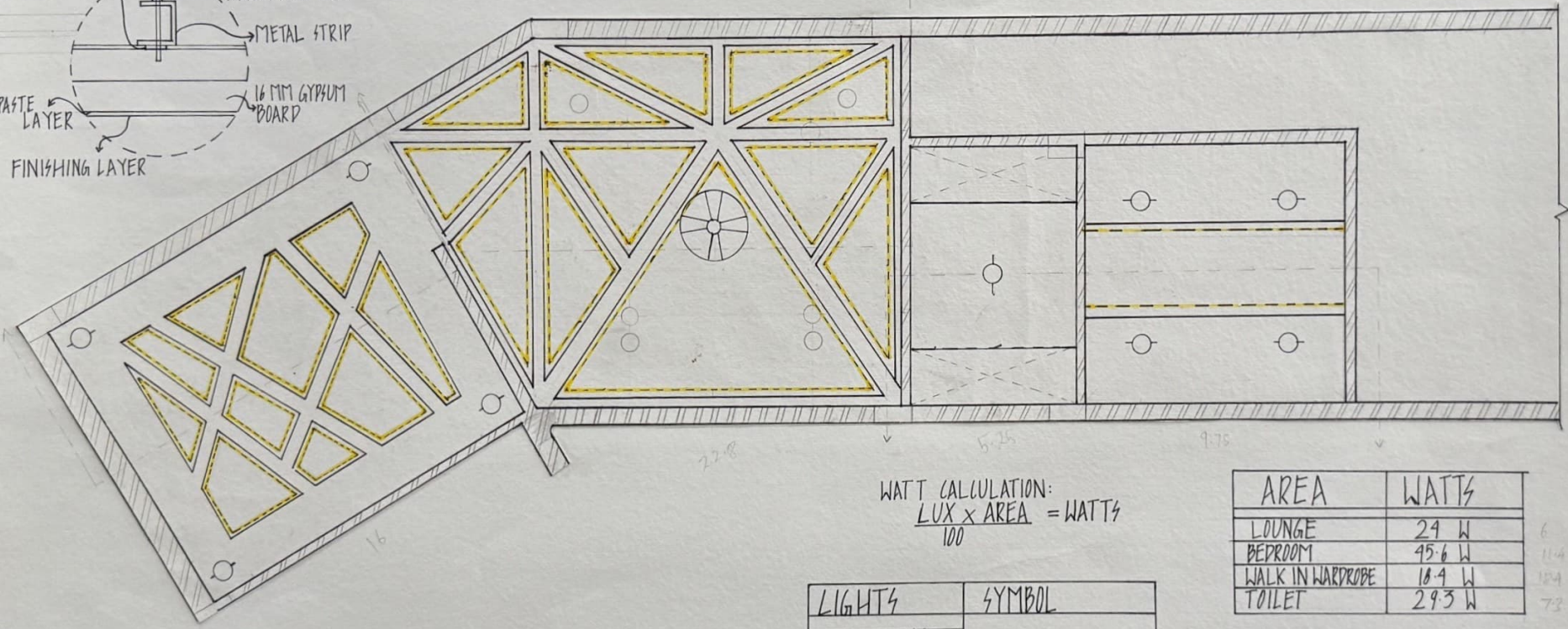
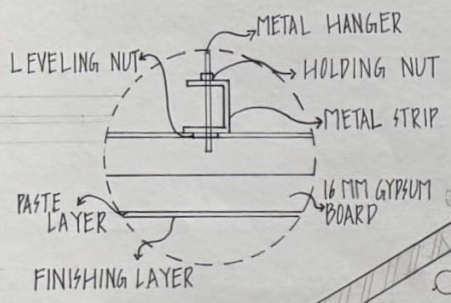
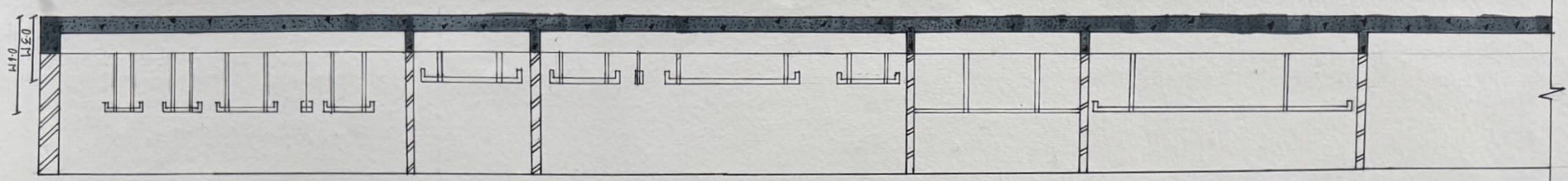

WATT CALCULATION:  

$$\frac{\text{LUX} \times \text{AREA}}{100} = \text{WATTS}$$

AREA	WATTS
LOUNGE	29 W
BEDROOM	45.6 W
WALK IN WARDROBE	18.4 W
TOILET	29.3 W

LIGHTS	SYMBOL
RECESSED LIGHTS	
STRIP LIGHTS	

# REFLECTED CEILING PLAN

NAME: MEDHA  
 RRN: 2 51431601016  
 CRESCENT SCHOOL OF ARCHITECTURE

# SECTION CC'

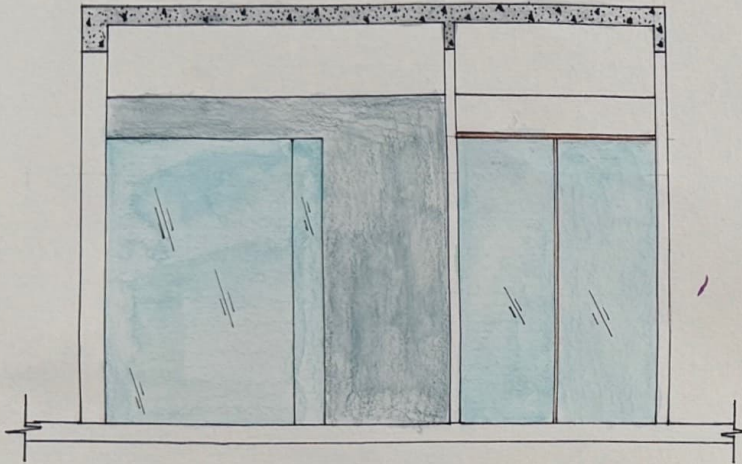

PLAN



# SECTION AA'

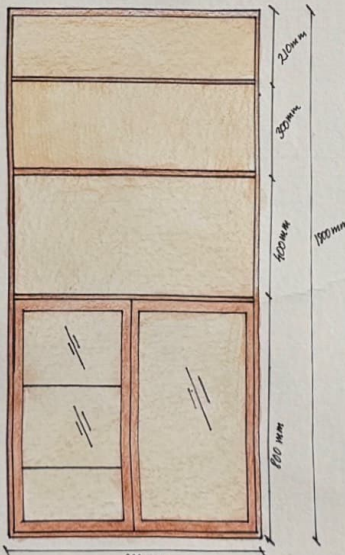
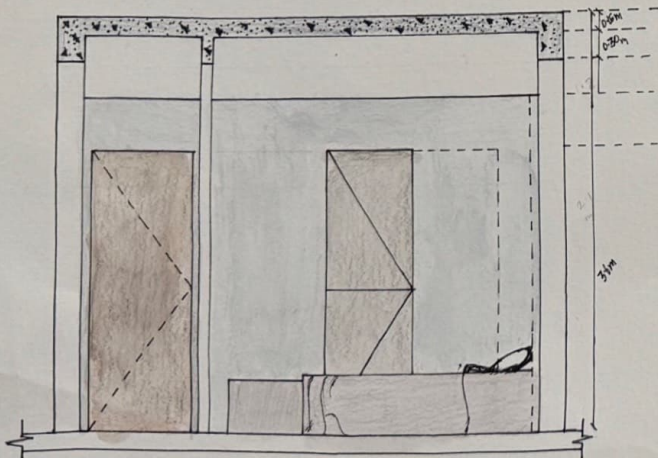

ELEVATION

# SECTION BB'

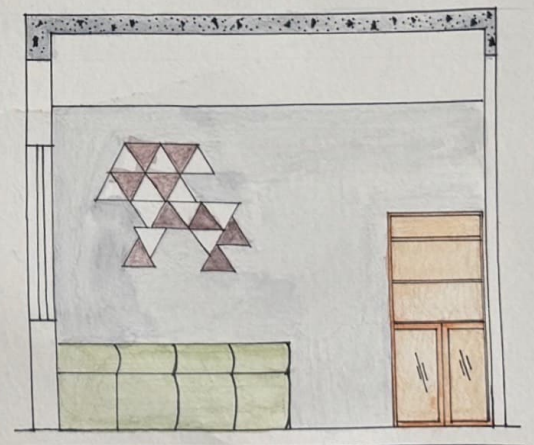

# MASTER BEDROOM SECTIONS

NAME: MEERHA  
RRN: 251931601016  
DESIGN ENVIRONMENT - II  
B.DES SEM - II

27

TV WALL VIEW

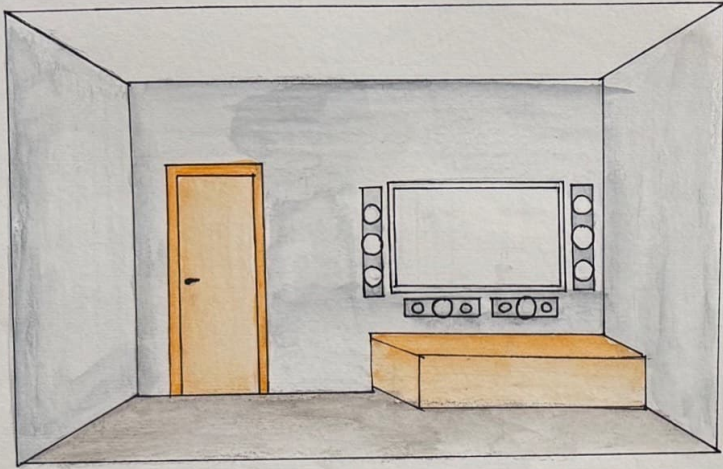

BATHROOM VIEW

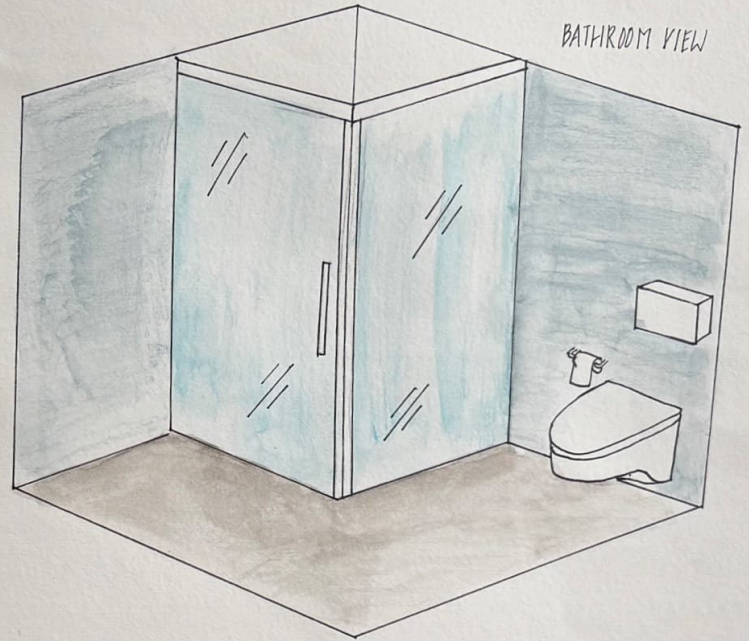

BEDSIDE VIEW

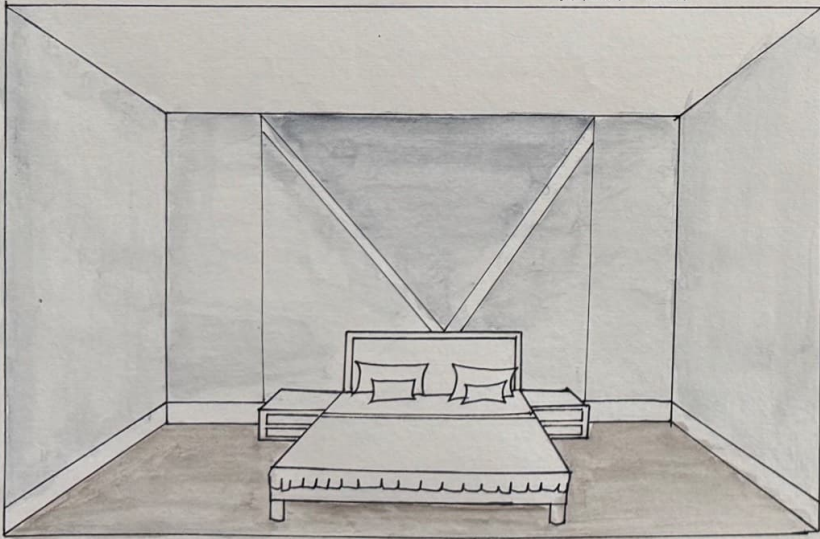

SOFA VIEW

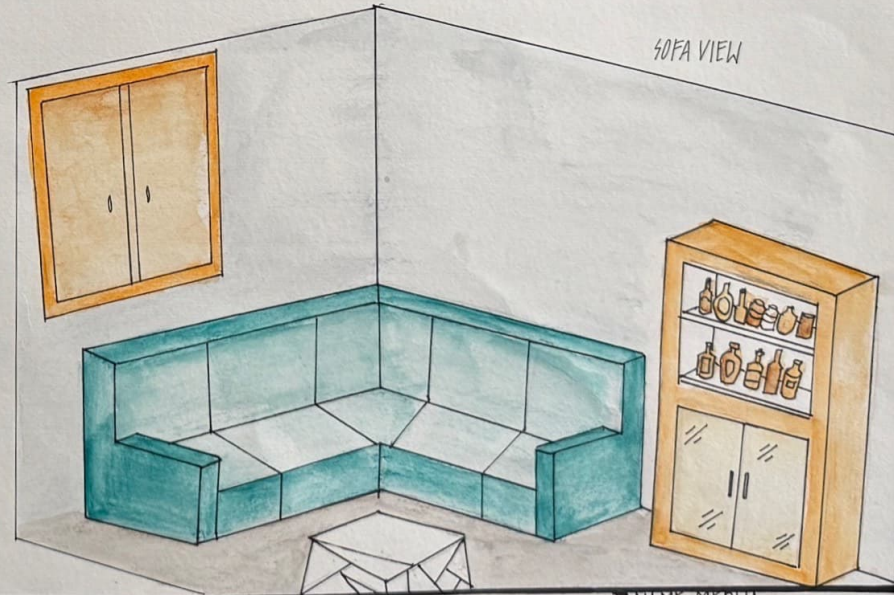

# MASTER BEDROOM VIEWS

NAME: MEDHA  
 RPN: 251431621016  
 BDES SEM-11  
 DESIGN ENVIRONMENT  
 CRECENT SCHOOL OF ARCHITECTURE