



Design Portfolio A Submission

Conveyor Belt City

William Rhys Farmer

G20757223

A4005

1:10000 port layout



1:10000 port layout

■ Conveyor

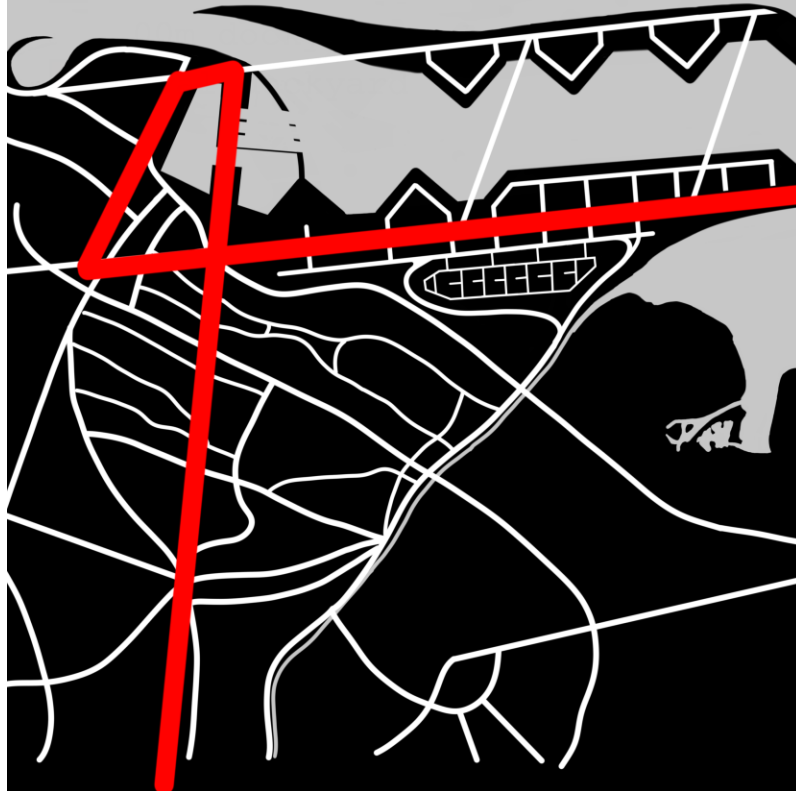

1:10000 port layout

■ Key places of interest



1:10000 port layout

Focus of project

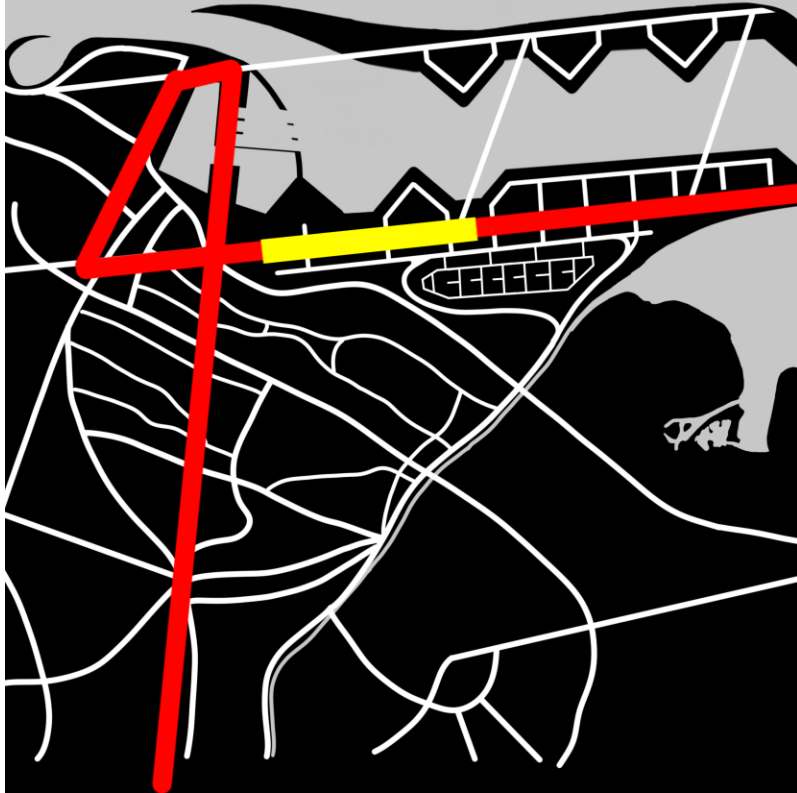

1:10000 port layout

- Free zone
- Passenger terminal
- Conventional dockyard
- 400m dockyard
- Naval dockyard
- Administration and customs

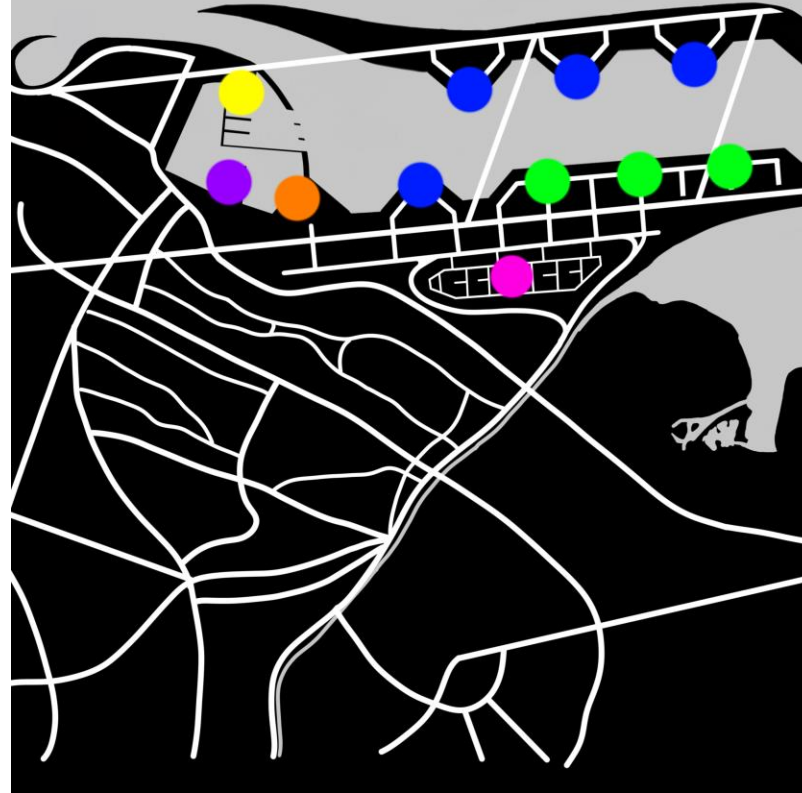

1:10000 port layout

- Completed by 2030
- Completed by 2050
- Completed by 2070





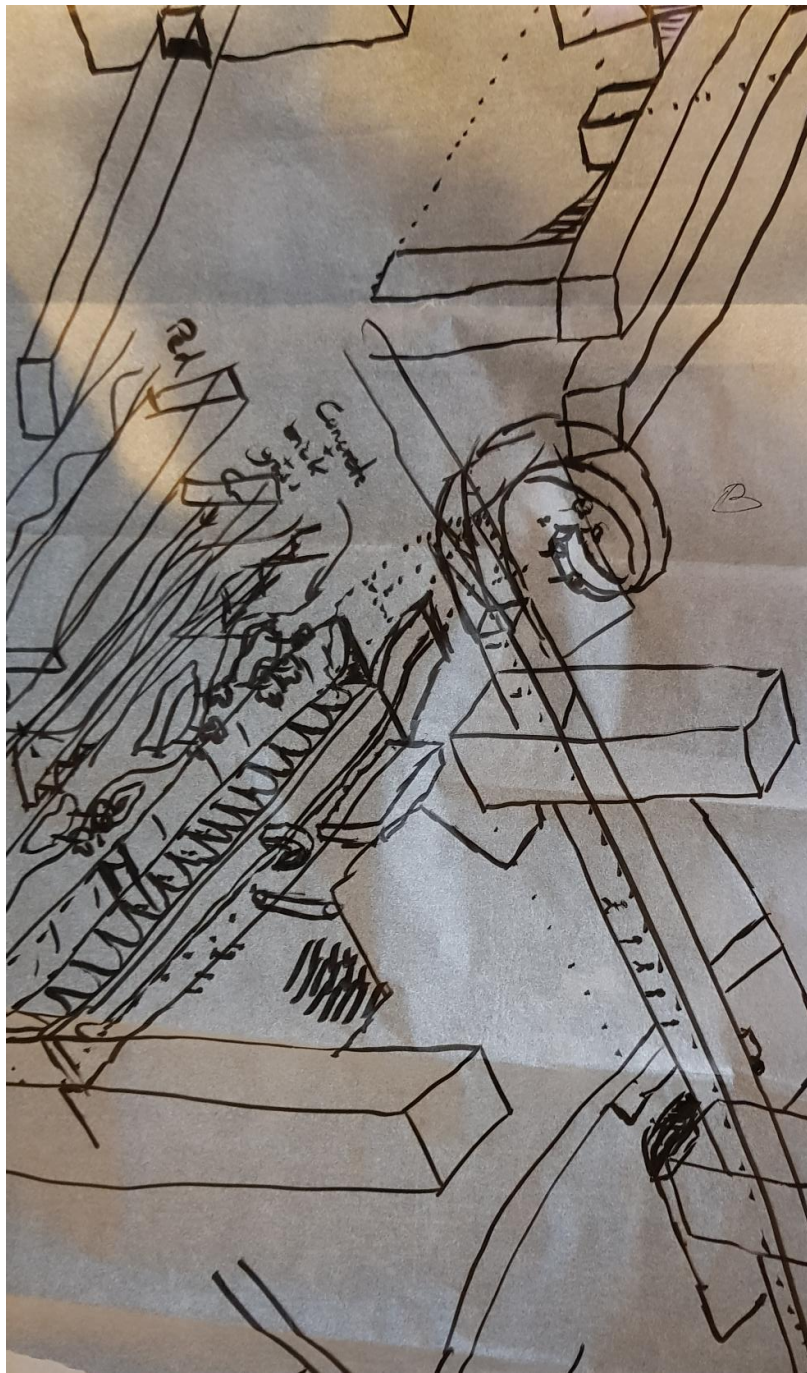
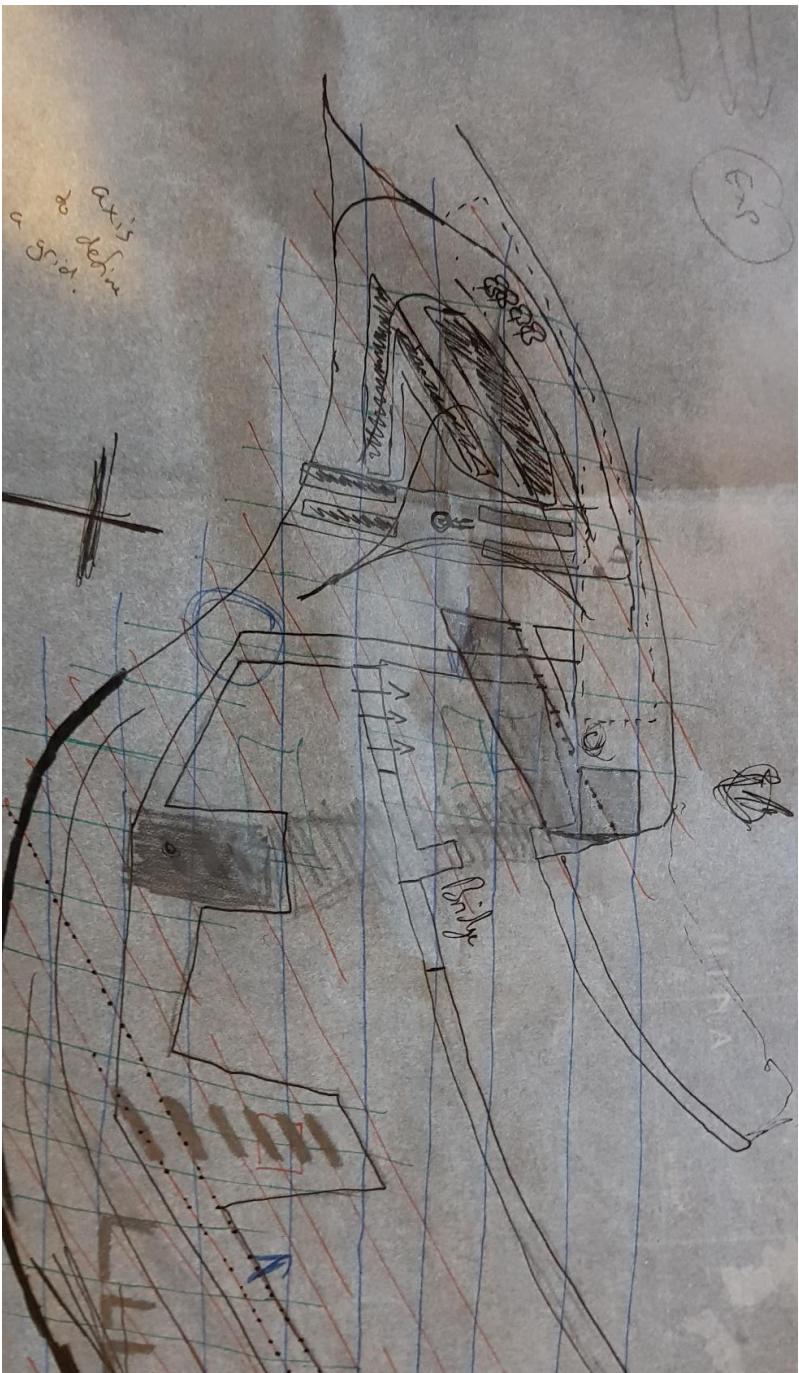



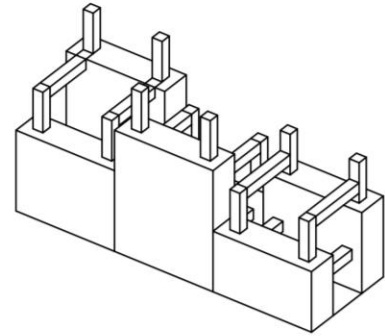
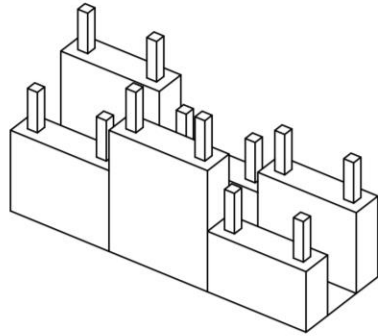
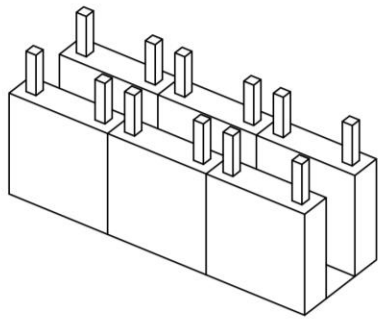
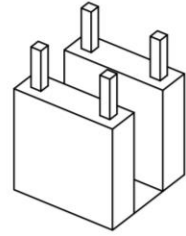
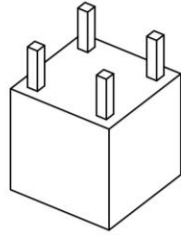
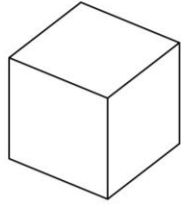

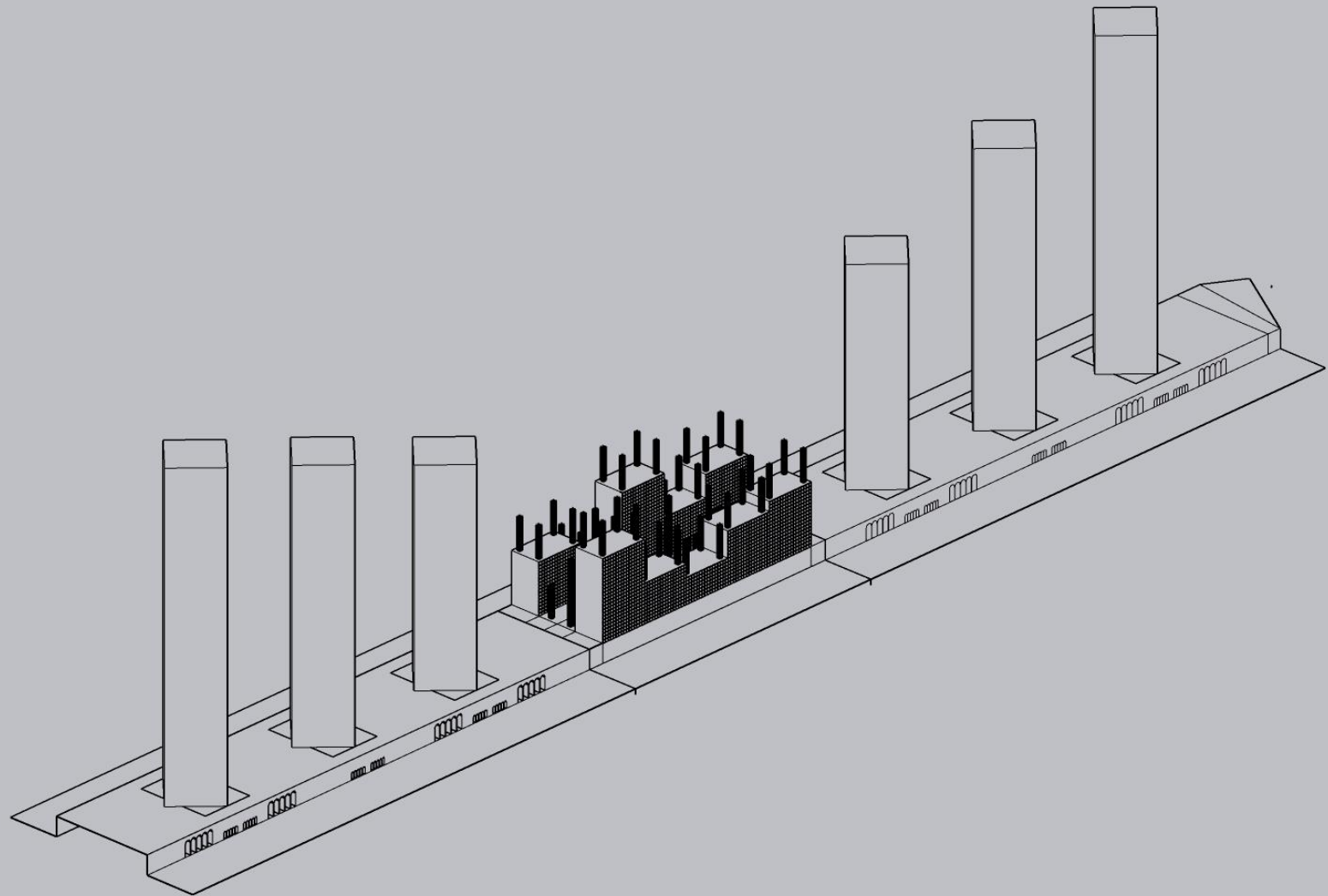

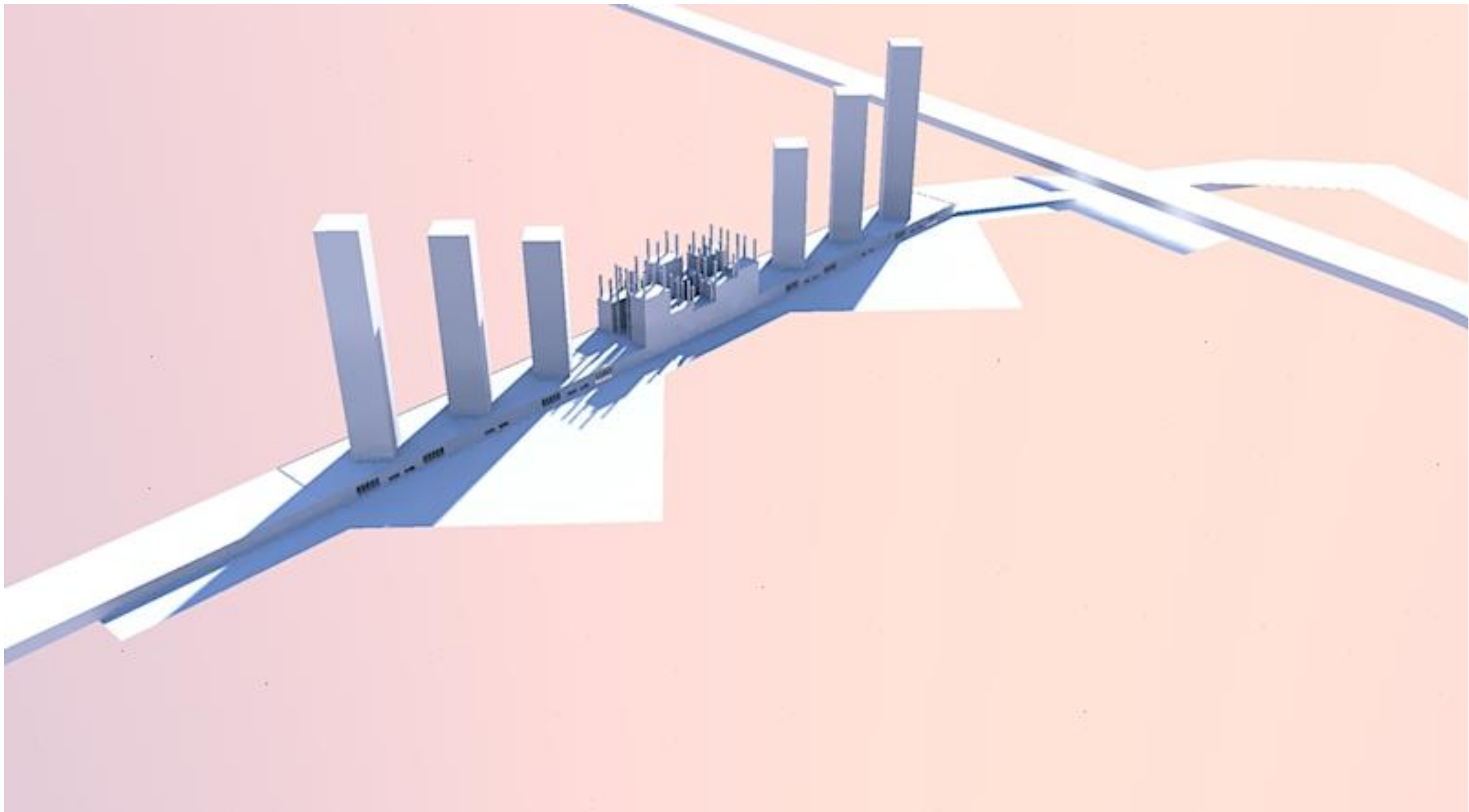

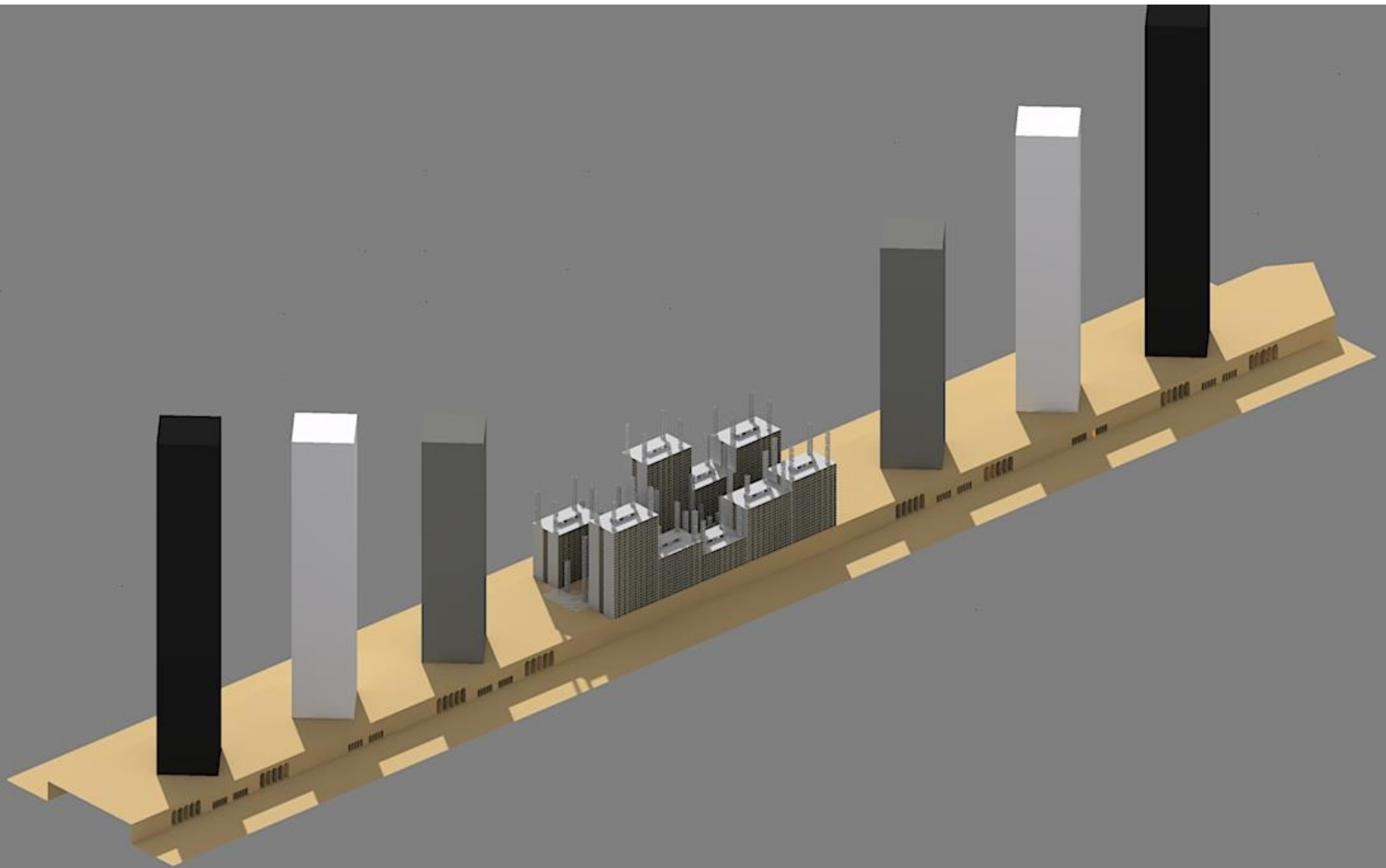

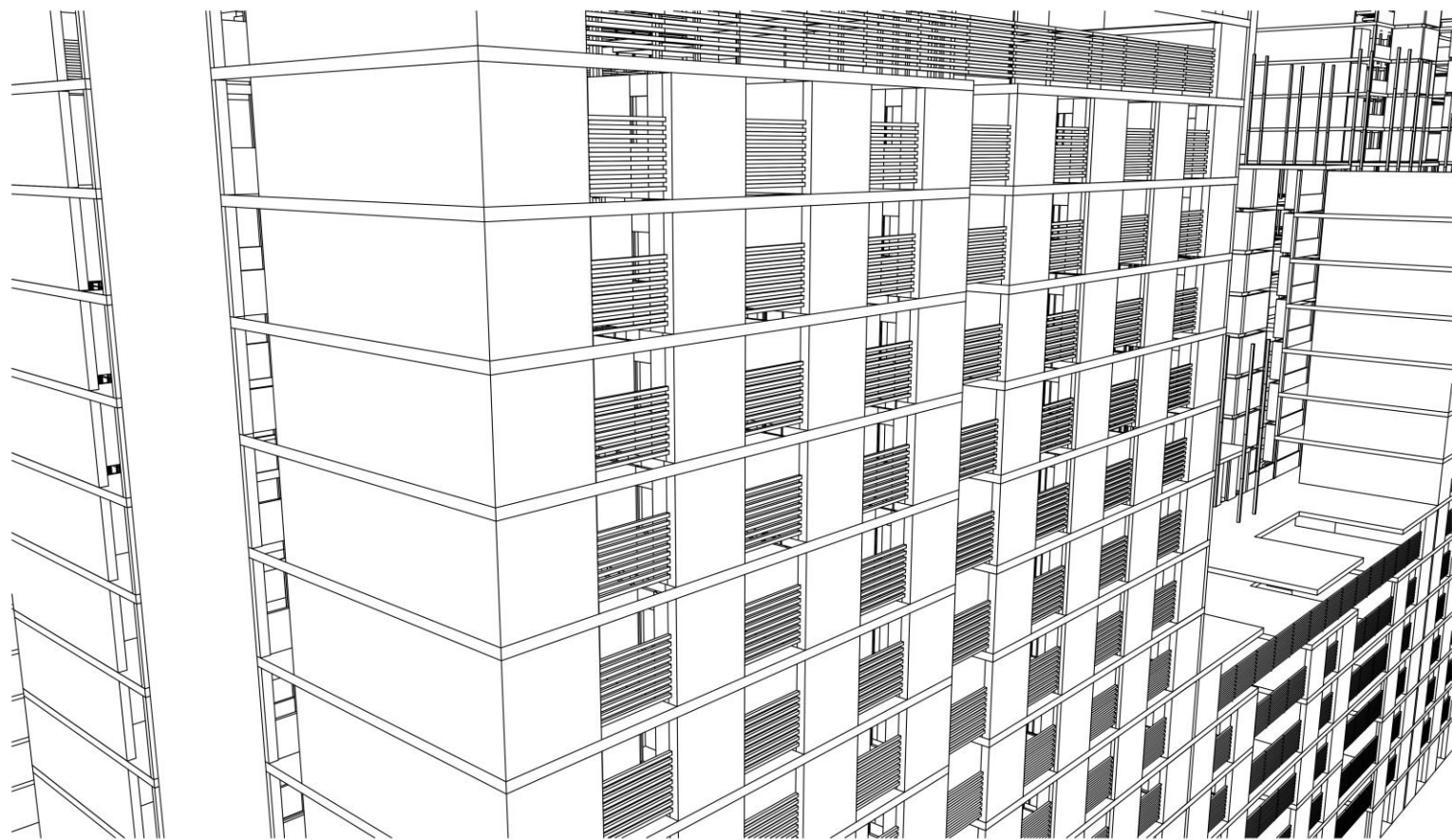

NW Elevation
1:500

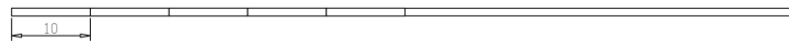
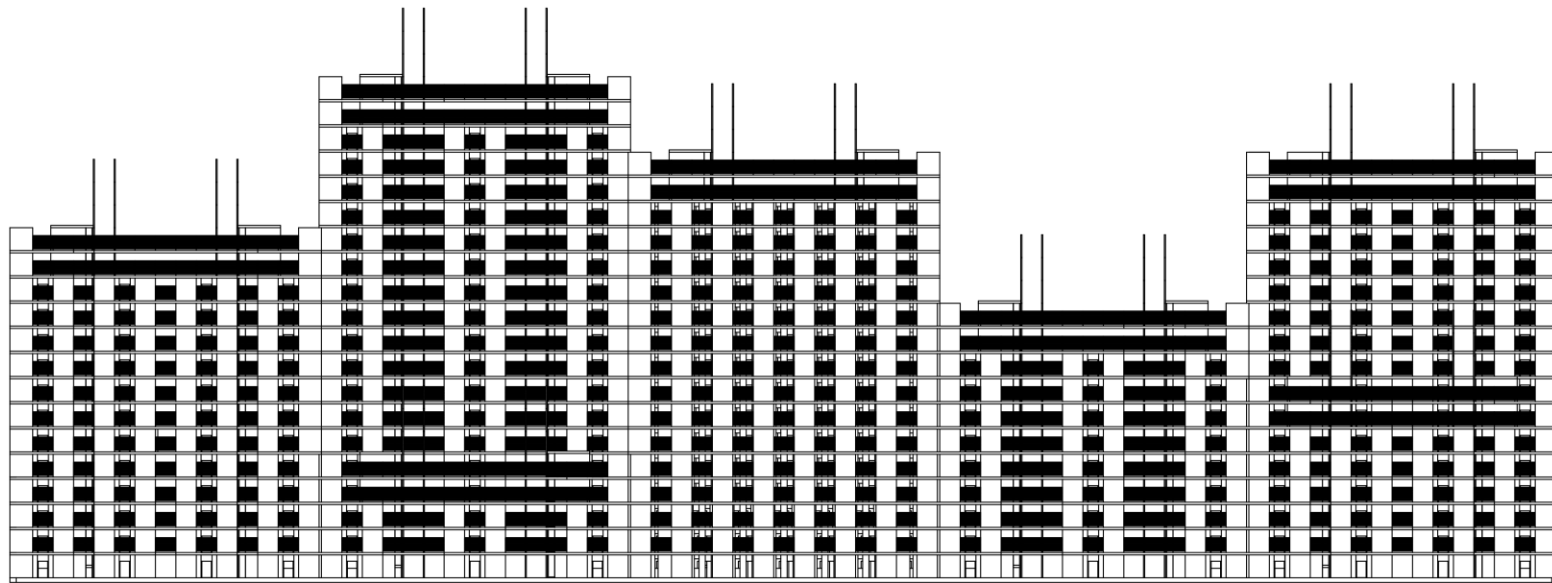

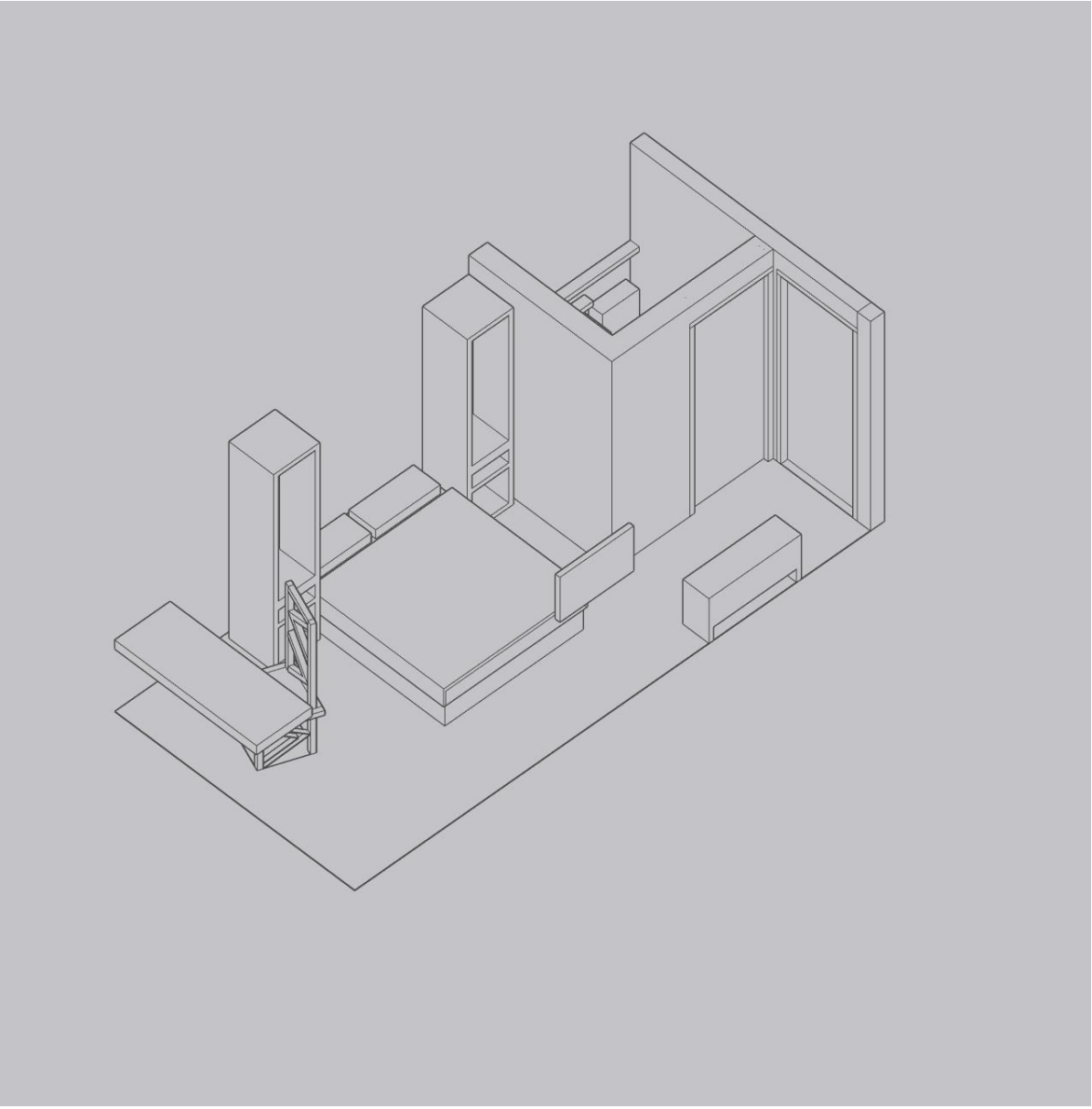
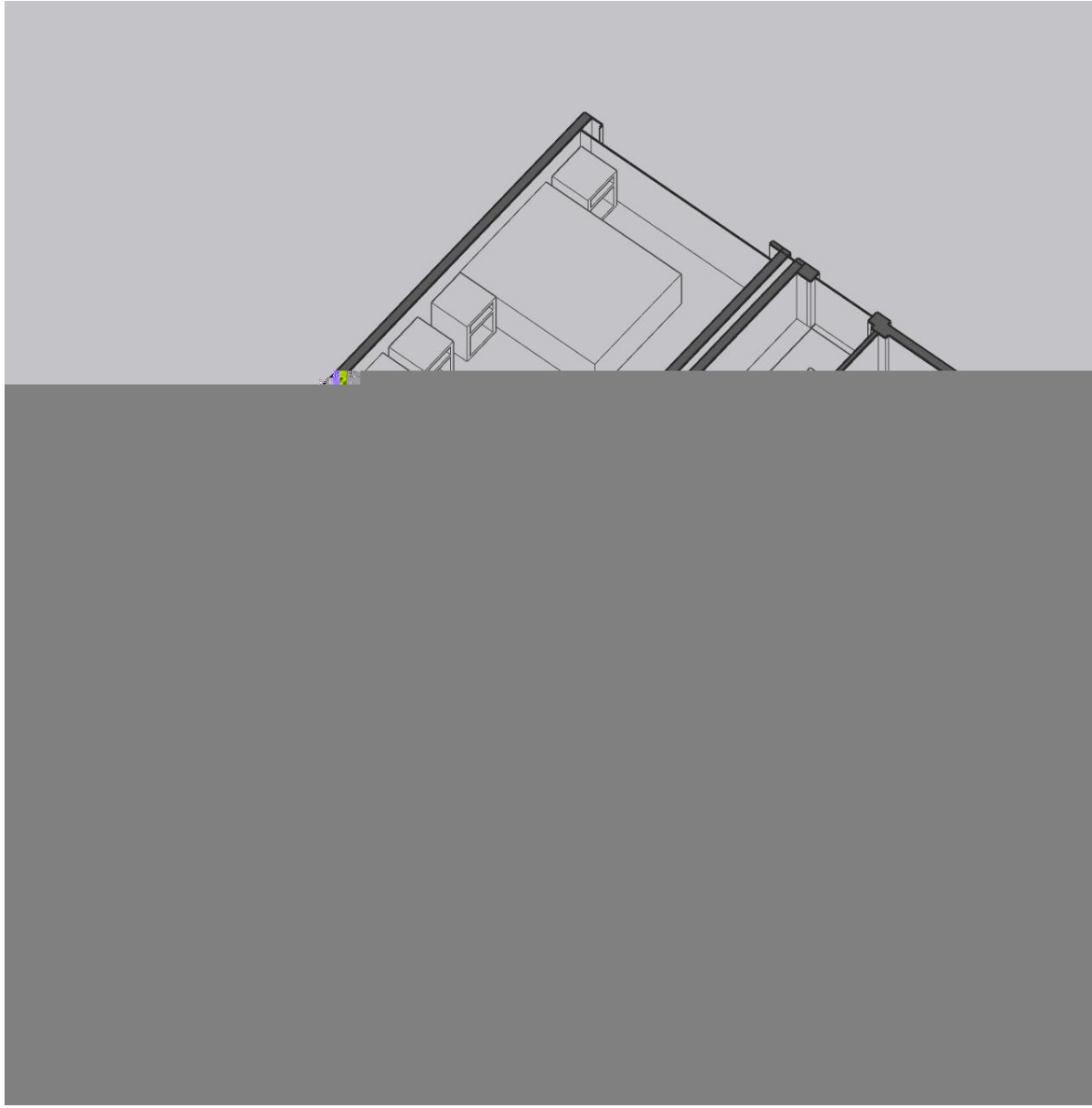

Ground Floor
1:500

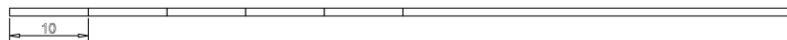
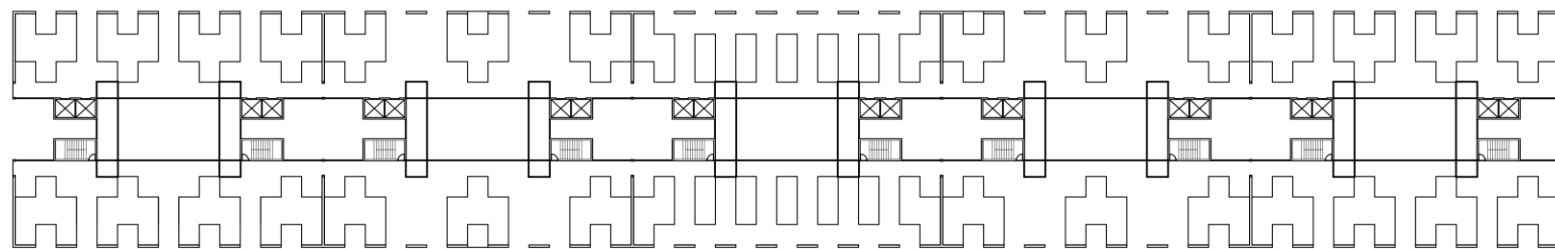
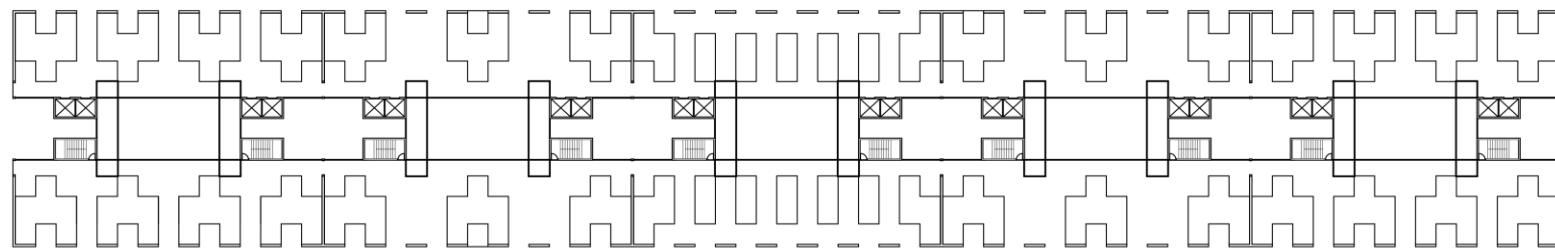

1st Floor
1:500

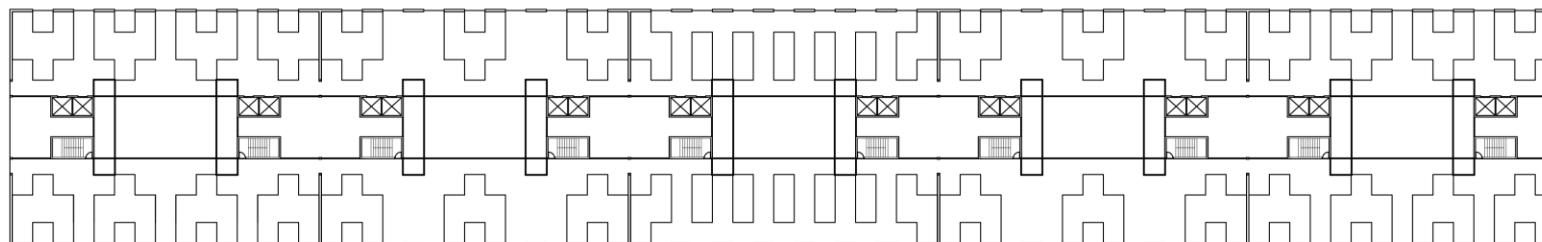
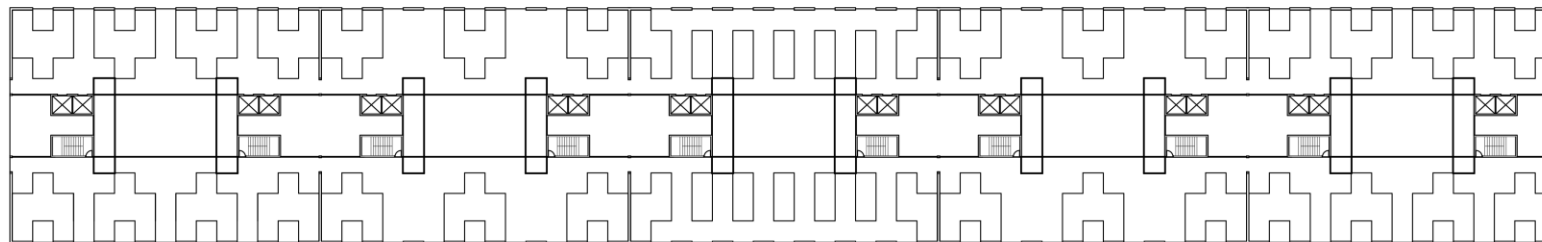

2nd Floor
1:500

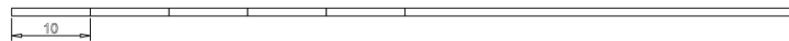
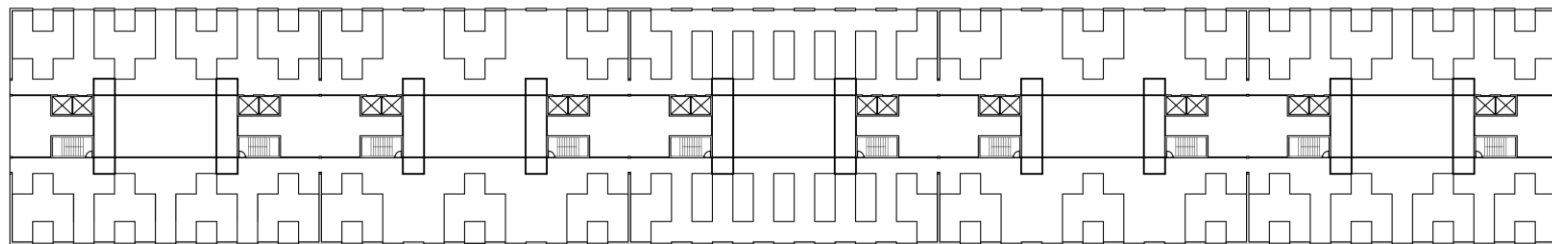
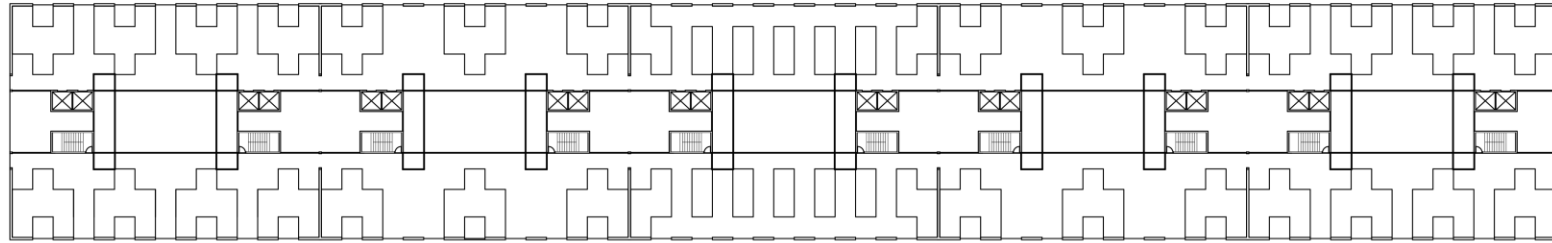

3rd Floor
1:500

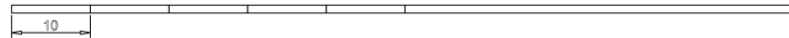
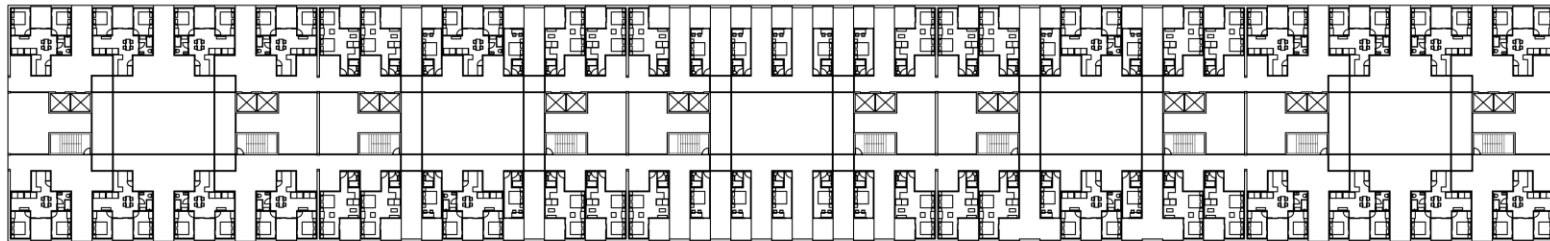
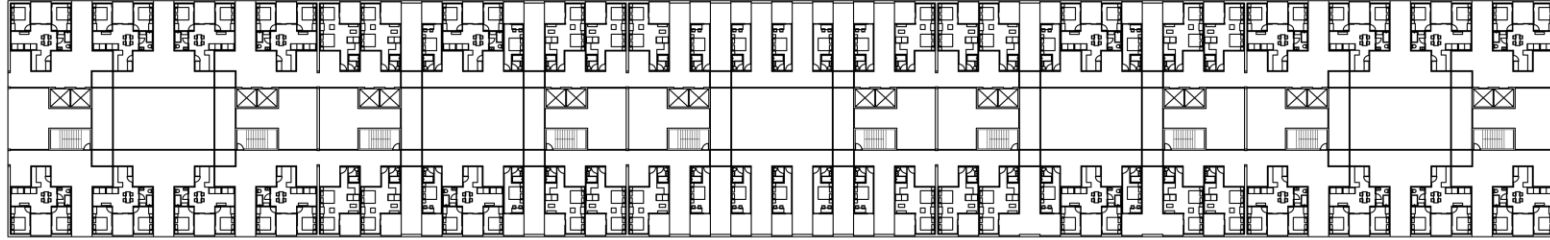

4th Floor
1:500

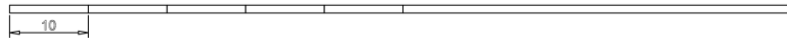
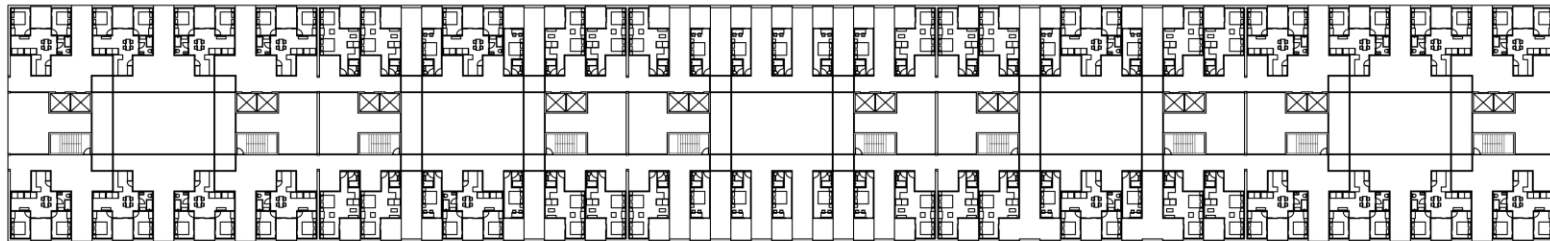
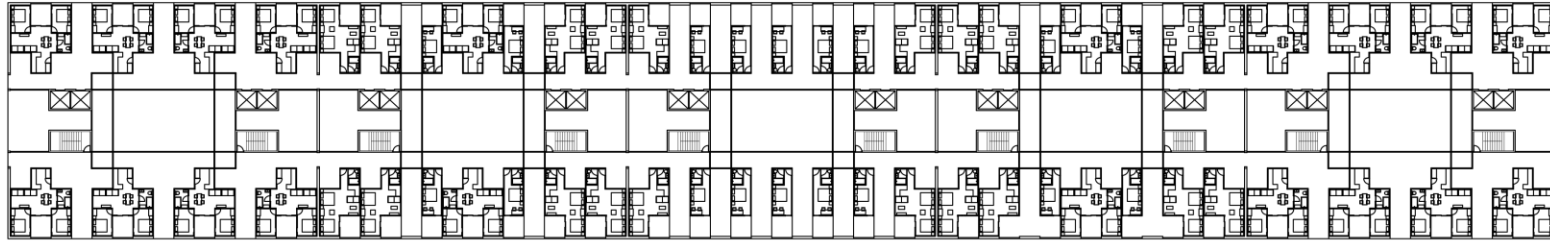

5th Floor
1:500

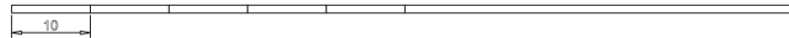
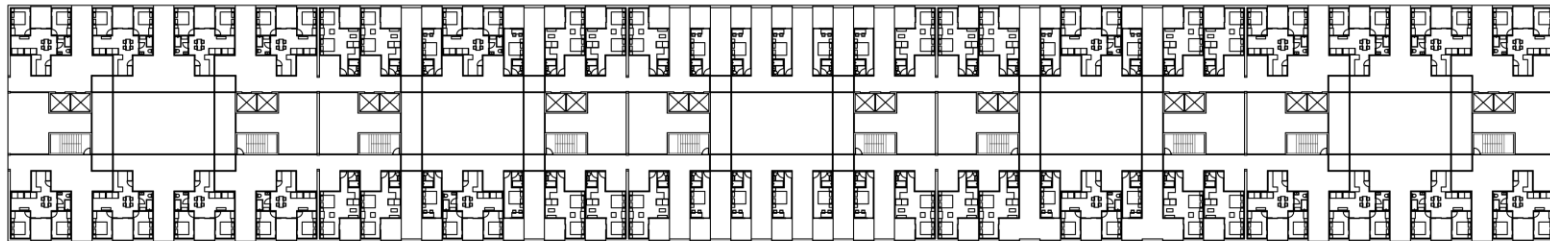
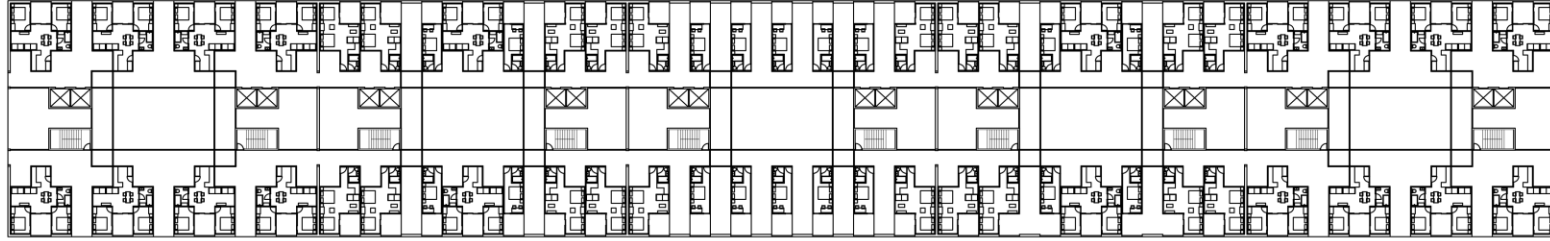

6th Floor
1:500

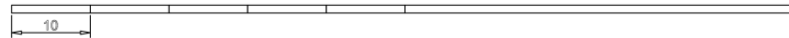
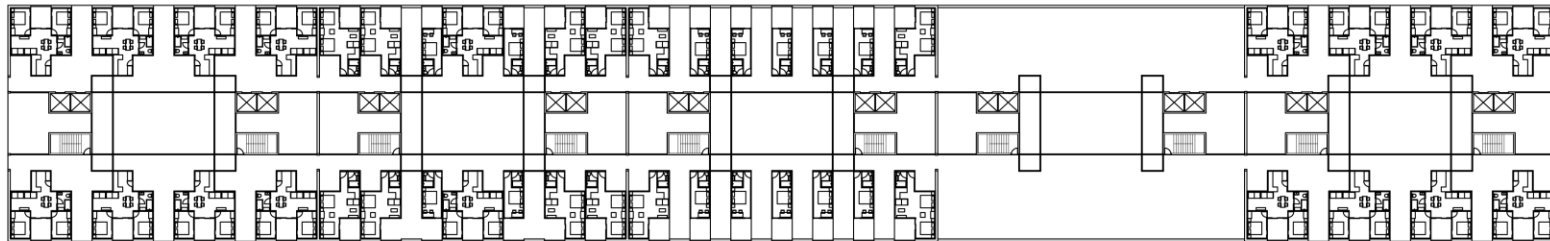
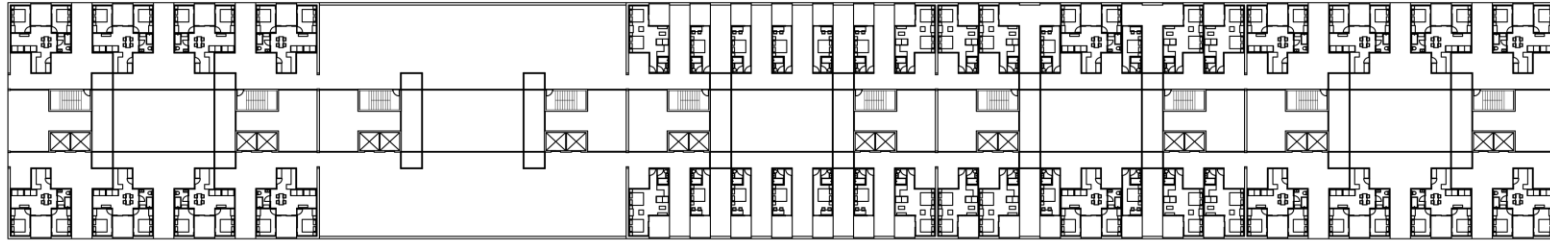

7th Floor
1:500

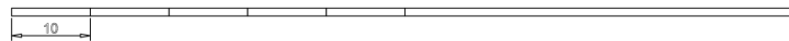
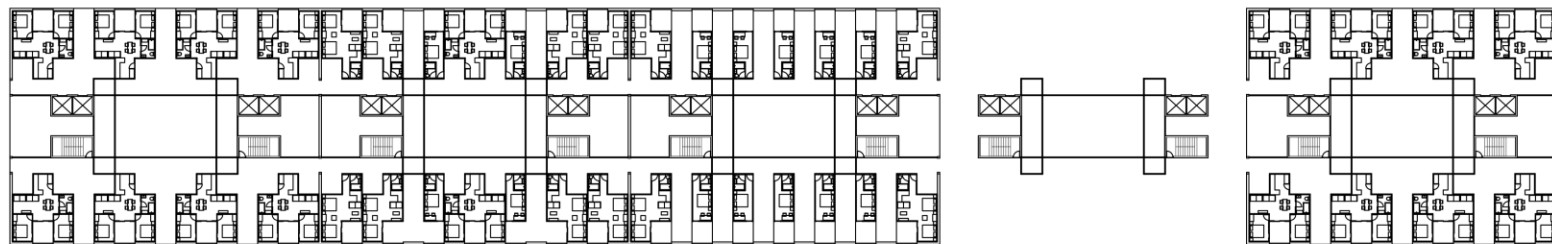
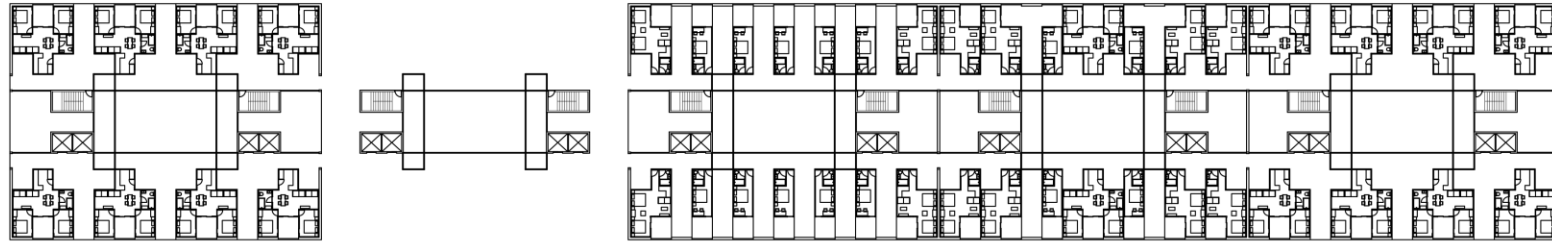

8th Floor
1:500

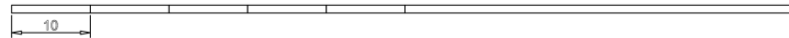
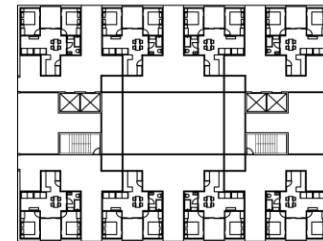

9th Floor
1:500

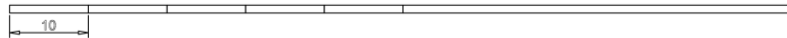
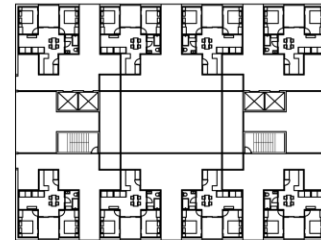
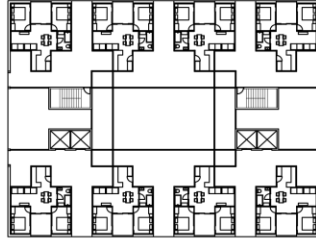

10th Floor
1:500

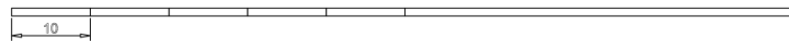
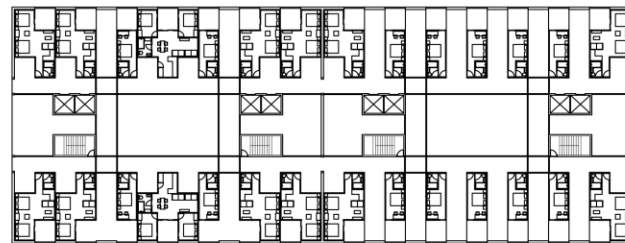
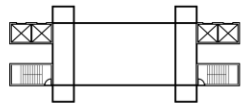
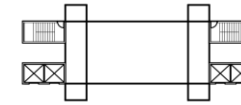
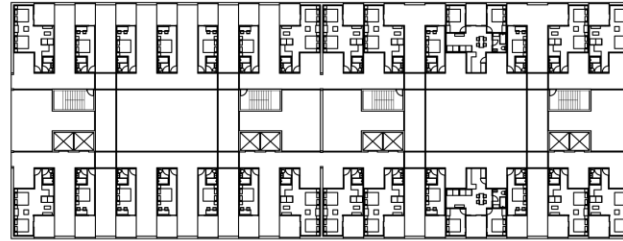
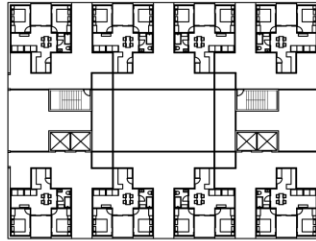

11th Floor
1:500

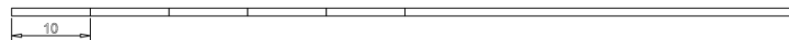
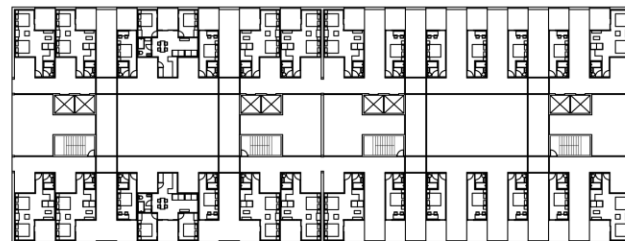
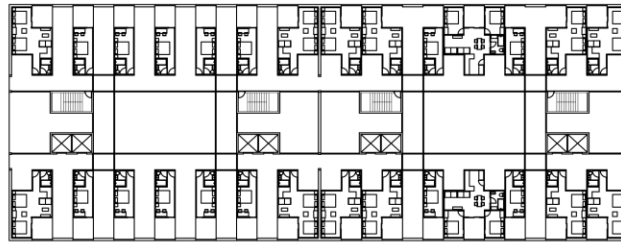
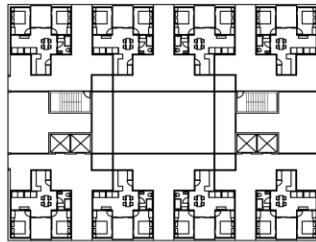

12th Floor
1:500

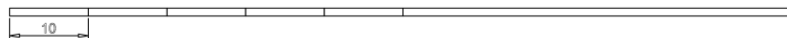
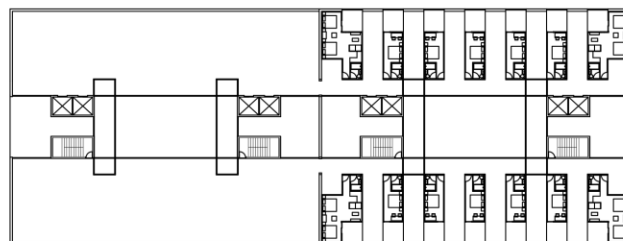
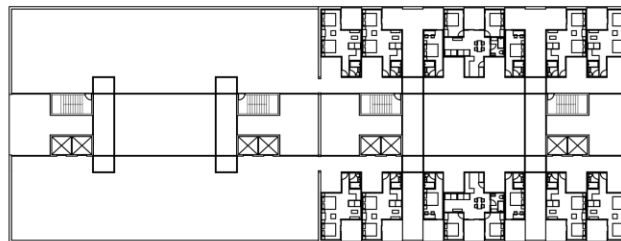
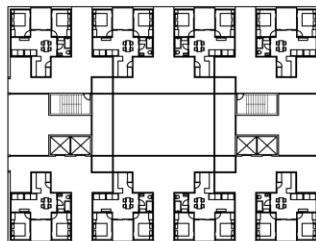

13th Floor
1:500

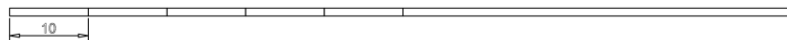
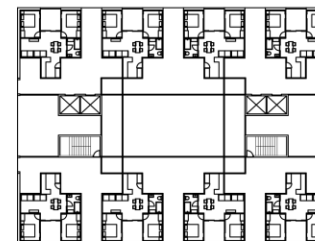
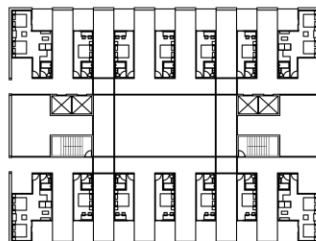
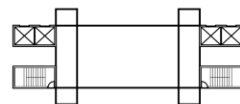
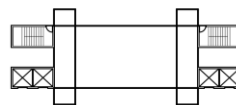
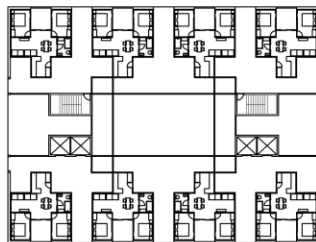

14th Floor
1:500

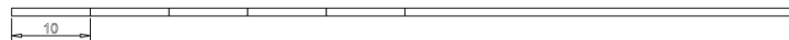
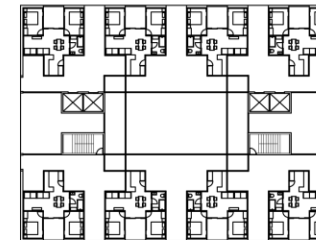
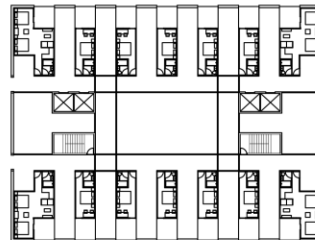
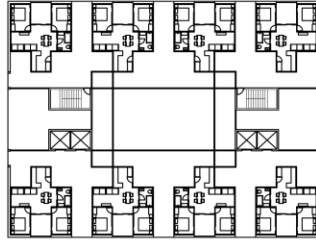

15th Floor
1:500

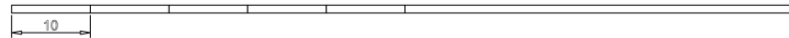
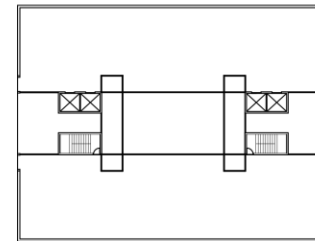
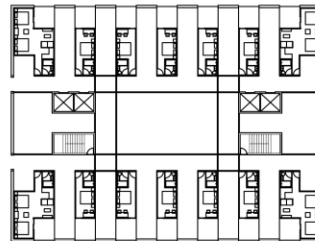
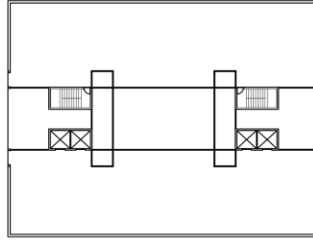

16th Floor
1:500

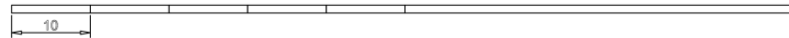
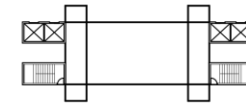
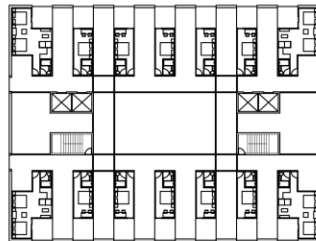

17th Floor
1:500

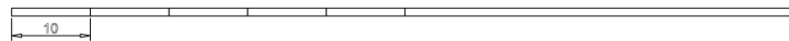
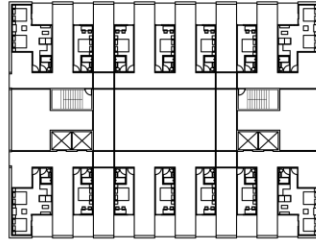

SE Elevation
1:500

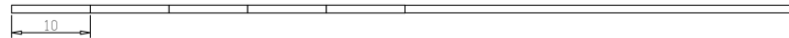
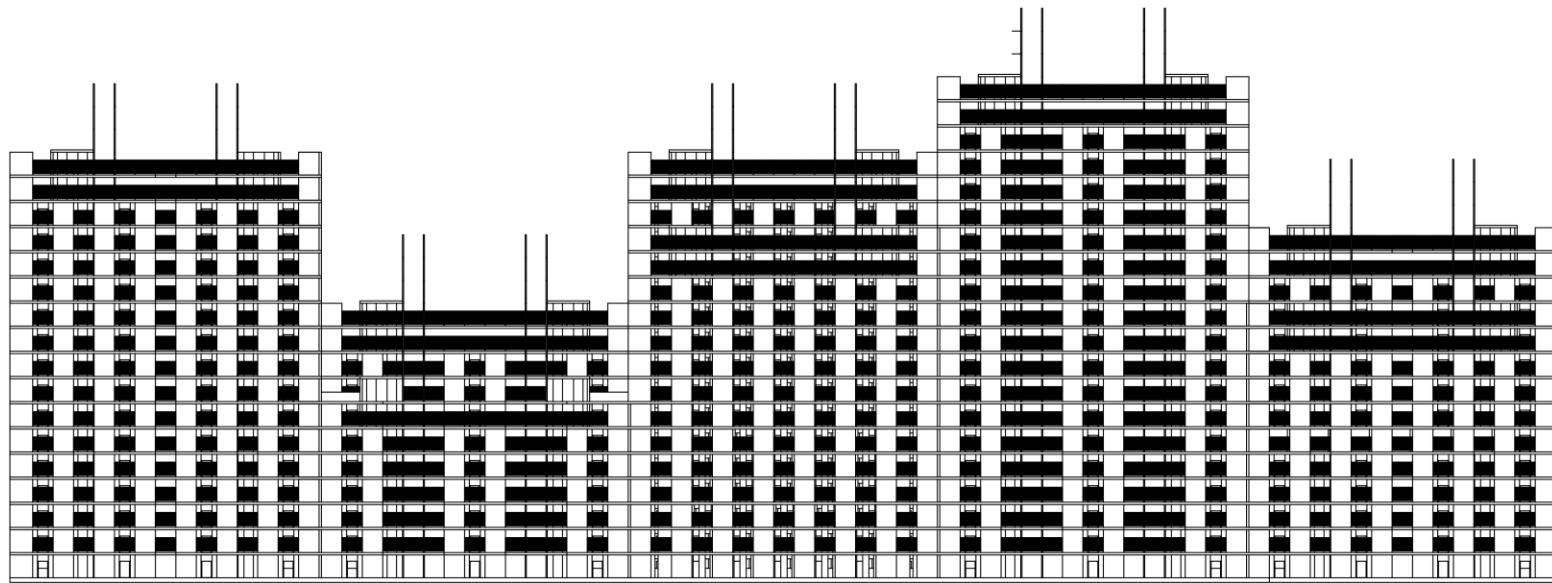

Section A-A
1:500

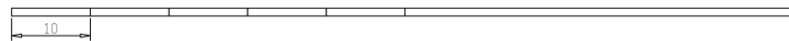
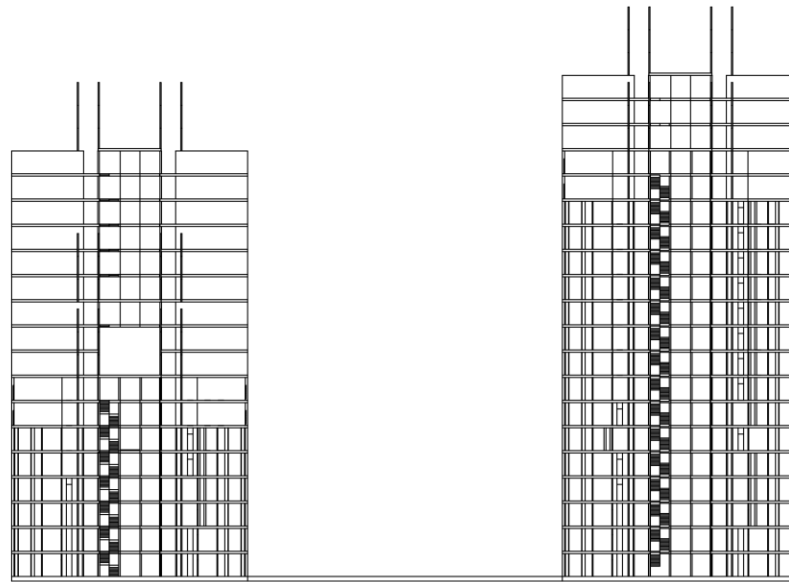

Section B-B
1:500

